

See discussions, stats, and author profiles for this publication at: <https://www.researchgate.net/publication/276074503>

Distortion Minimization in Multi-Sensor Estimation Using Energy Harvesting and Energy Sharing

Article in IEEE Transactions on Signal Processing · June 2015

DOI: 10.1109/TSP.2015.2416682

CITATIONS

28

READS

80

4 authors, including:



Subhrakanti Dey

University of Melbourne

161 PUBLICATIONS 1,971 CITATIONS

SEE PROFILE



Daniel Quevedo

Universität Paderborn

276 PUBLICATIONS 6,255 CITATIONS

SEE PROFILE

Some of the authors of this publication are also working on these related projects:



Modular multilevel converter [View project](#)



Discrete-valued control [View project](#)

Distortion Minimization in Multi-Sensor Estimation Using Energy Harvesting and Energy Sharing

Steffi Knorn, *Member, IEEE*, Subhrakanti Dey, *Senior Member, IEEE*, Anders Ahlén, *Senior Member, IEEE*, and Daniel E. Quevedo, *Senior Member, IEEE*

Abstract—This paper investigates an optimal energy allocation problem for multisensor estimation of a random source where sensors communicate their measurements to a remote fusion center (FC) over orthogonal fading wireless channels using uncoded analog transmissions. The FC reconstructs the source using the best linear unbiased estimator (BLUE). The sensors have limited batteries but can harvest energy and also transfer energy to other sensors in the network. A distortion minimization problem over a finite-time horizon with causal and noncausal centralized information is studied and the optimal energy allocation policy for transmission and sharing is derived. Several structural necessary conditions for optimality are presented for the two sensor problem with noncausal information and a horizon of two time steps. A decentralized energy allocation algorithm is also presented where each sensor has causal information of its own channel gain and harvested energy levels and has statistical information about the channel gains and harvested energies of the remaining sensors. Various other suboptimal energy allocation policies are also proposed for reducing the computational complexity of dynamic programming based solutions to the energy allocation problems with causal information patterns. Numerical simulations are included to illustrate the theoretical results. These illustrate that energy sharing can reduce the distortion at the FC when sensors have asymmetric fading channels and asymmetric energy harvesting processes.

Index Terms—Energy allocation, energy harvesting, energy sharing, fading channels, multisensor estimation.

I. INTRODUCTION

ADVANCES in the field of wireless communication have enriched many practical applications. A key role in this development is played by wireless sensors that measure a signal of interest and transmit the measurements to a remote estimator (“Fusion Centre” or FC). As wireless sensors have become not only more powerful but also more affordable and compact, they are increasingly being used in many areas such as environmental data gathering [1], industrial process monitoring [2], mobile

robots and autonomous vehicles [3], and for monitoring of smart electricity grids [4]. It is well known that multi-sensor estimation may provide a significant reduction in the reconstruction error, or distortion at the FC.

Sensors are often located in remote places and therefore sometimes cannot be connected to reliable power sources. Even if connecting sensors to the electricity grid is feasible, it can be beneficial not to do so to simplify the installation process, facilitate changing the position of sensors or ensure sensors are independent of the power grid. Thus, sensors are often powered by batteries. Relying on battery power involves another significant restriction: As changing batteries is usually costly and undesirable, sensors have to be designed such that the limited available energy in the battery is used in the most efficient way, see [5]–[7] and the references therein.

One way to help to overcome the limitations outlined above is to use energy harvesting. Often sensors are placed in an environment where energy can be harvested using solar panels, wind mills or other technical devices. The harvested energy can then be used for immediate data transmission or be stored in the battery for future use. Because of the unreliable nature of most renewable energy sources, allocating the available energy in an optimal fashion to ensure the best possible performance of the network is a challenging task.

In recent years, a number of authors have addressed the problem of optimal transmission energy allocation policy for optimizing various metrics related to information transmission when the transmitters are equipped with energy harvesting capability. In [8], throughput optimal and mean delay optimal energy allocation policies in a single sensor node are studied. The optimal energy allocation policies that maximize the mutual information of a wireless link were derived in [9] under either causal or non-causal side information available at the transmitters. In [10], the authors investigated an optimal packet scheduling problem for a single-user energy harvesting wireless communication system, where data packets and energy packets arrive at the transmitter in a random manner. They develop optimal off-line scheduling policies for minimizing the delivery time for all packets to the destination in a deterministic setting where the energy harvesting times and the amounts of energy harvested are all known before transmission starts. While no finite battery capacity is assumed in [10], optimal off-line transmission policies with batteries with limited storage capacities are investigated in [11], where a short-term (finite horizon) throughput maximization and the related problem of minimization of the transmission completion time for a given amount of data are studied. These results are further generalized

Manuscript received October 24, 2014; revised January 30, 2015; accepted March 15, 2015. Date of publication March 25, 2015; date of current version May 04, 2015. The associate editor coordinating the review of this manuscript and approving it for publication was Prof. Rui Zhang.

S. Knorn, S. Dey, and A. Ahlén are with the Department of Engineering Sciences, Uppsala University, Sweden (e-mail: steffi.knorn@angstrom.uu.se; subhra.dey@angstrom.uu.se; anders.ahlen@angstrom.uu.se).

D. E. Quevedo is with the Department of Electrical Engineering (EIM-E), The University of Paderborn 33098 Paderborn, Germany (e-mail: dquevedo@ieee.org).

Color versions of one or more of the figures in this paper are available online at <http://ieeexplore.ieee.org>.

Digital Object Identifier 10.1109/TSP.2015.2416682

in [12] where fading channels and optimal online policies are considered.

In addition to energy harvesting, wireless energy transfer technology is recently gaining traction as it becomes more efficient and less costly. It has the potential to be used to recharge batteries of future wireless sensors. It was successfully experimentally validated and reported in [13] that energy can be efficiently transferred between two resonant objects of the same resonant frequency. Efficiencies of over 50% were achieved for distances up to 2 meters. By choosing different resonant frequencies between each pair coupled by an energy transfer link, it is hence possible to allow for highly efficient energy transfer. See also [14] for similar energy transfer. Another promising experiment conducted by Mitsubishi Heavy Industries demonstrated effective wireless energy transfer of 10 kW over 500 m, [15]. Not surprisingly, an increasing number of companies has shown an interest in developing wireless energy transfer product, [16], [17]. Their applications range from small devices such as cell phones in coffee shops [18] to charging electric vehicles [19]. Apparently a lot of the necessary technology is readily available and it is merely a question of time when the application of wireless energy transfer becomes feasible in a wider range of technical areas [20]. Other researchers have investigated how to optimally transmit energy and information through wireless communication channels [21]–[25]. In contrast to the energy transfer techniques discussed in [13], [14], the energy is assumed to be broadcast in all directions in [21]–[25].

Some researchers have already started to investigate the potential benefits wireless energy transfer could bring to wireless sensor systems. A wireless sensor network with a fixed base station and a wireless charging vehicle driving from sensor to sensor was considered in [26] and [27] referring to energy transfer as discussed in [13].

As background for our current work, in [28], an optimal power allocation policy is derived and multiple necessary conditions for optimality are given for throughput maximization at a two-hop relay channel with one-way energy transfer from the source to the relay. In the same paper, throughput maximization for a Gaussian two-way channel with one-way energy transfer is investigated. It is shown that the optimal energy allocation policy is a directional two-way water filling algorithm, where one dimension relates to time while the second dimension describes the relationship between users.

This paper investigates an energy harvesting wireless sensor system (also known as a star-network) used to remotely estimate an independent and identically distributed band-limited Gaussian process. Sensor measurements are sent via orthogonal fading wireless channels to the FC, which uses the best linear unbiased estimator (BLUE), [29], to obtain an estimate of the physical process. While many of the previously mentioned works focused on throughput maximization or delay minimization with energy harvesting transmitters, we focus on distortion minimization over a finite horizon in a multi-sensor estimation systems. This problem has been recently addressed in [30], [31] where only energy harvesting sensors are considered (see also [32], [33] for related work). The novelty in the current paper lies in considering sensors that can not only harvest energy from

their environment, but can also share energy between neighboring nodes. Another important novelty of our work is to allow energy transfer between an arbitrary number of sensors (instead of a simple two sensor system) in both directions (instead of a one-directional energy transfer as considered in [28]). As we consider distortion minimization over a finite horizon over a dynamic fading environment, allowing energy transfer in both directions is shown to be beneficial especially when the sensors have asymmetric channel gain and harvested energy statistics. In particular, the following main contributions can be distilled:

- 1) We study the optimal energy allocation policy for transmission and sharing for a finite-horizon sum distortion minimization assuming centralized (at the FC) non-causal information and unlimited battery capacities using standard convex optimization techniques. This leads to several structural necessary conditions and interpretations of the optimal energy allocation policy as a type of two-dimensional directional water filling algorithm (Section III).
- 2) We obtain structural results for a two-sensor system considering non-causal information and a time-horizon of 2 (Section IV). This insight is used to design a heuristic *ad hoc* energy allocation policy later in Section VII-B, see also contribution (5).
- 3) We obtain optimal energy allocation policies with causal centralized and also decentralized information at the FC based on dynamic programming techniques in Section V and Section VI, respectively.
- 4) We present some suboptimal, heuristic policies that have significantly less computational complexity (Section VII) than the dynamic programming based solutions and yet provide a good performance.
- 5) A comprehensive set of numerical studies are presented to illustrate the comparative performance of the various energy allocation policies and the benefits of optimal energy sharing (Section VIII).

The rest of the paper is organized as follows. The system model is introduced in Section II. Section III presents the optimal energy allocation policies for finite horizon distortion minimization with non-causal information and unlimited batteries, followed by some structural results for the simple special case of a 2 sensor system with non-causal information and a time-horizon of 2 in Section IV. Section V presents the optimal energy allocation policy for the causal information case, whereas Section VI presents the policies for the decentralized information pattern. Some reduced-complexity suboptimal schemes are presented in Section VII. Numerical examples illustrating the performance of the various policies are given in Section VIII, followed by some concluding remarks in Section IX.

II. SYSTEM MODEL

We consider a system with M sensors individually measuring a random process of interest $\theta(k)$, $k \in \{1, 2, 3, \dots\}$. All measurements are subject to measurement noise. The remote sensors can transmit information to a fusion centre (FC). The latter estimates $\theta(k)$ given the available measurements. The transmitters adopt an analog amplify and forward uncoded strategy subject to additive noise. Every sensor node has a local battery

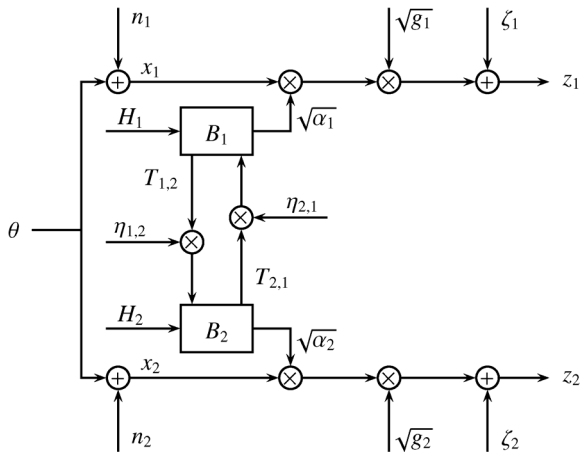

Fig. 1. System model for two sensors.

whose energy can be used for data transmission and an energy unit to harvest energy from its environment. In addition each sensor is equipped with a unit to transmit and receive energy from other sensors subject to individual transmission losses. A scheme showing a simple system with two sensors can be found in Fig. 1. The description of the individual parts is given below.

A. Source Model and Sensor Measurements

We consider the case where $\theta(k)$ is an independent and identically distributed (i.i.d.) Gaussian process with zero mean and variance σ_θ^2 . The measurements of sensor m , $x_m(k)$, are subject to measurement noise, $n_m(k)$, such that

$$x_m(k) = \theta(k) + n_m(k) \quad (1)$$

for $1 \leq m \leq M$ and $k \geq 1$. The measurement noise processes $n_m(k)$ are assumed to be i.i.d. Gaussian, mutually independent and independent of $\theta(k)$, have zero mean and variances σ_m^2 .

B. Energy Harvester, Energy Sharing and Battery Dynamics

Each sensor has access to an energy harvester that can gather energy from the environment. The amount of energy available to be harvested at sensor m at time slot k , denoted by $H_m(k)$, is described by an i.i.d. process. It is assumed that the harvested energy, the process $\theta(k)$, the measurement noise and the channel gains are mutually independent. The energy harvested at time slot k is stored in the battery and can be used for data transmission or also for energy sharing in the following time slot $k+1$. Assume that transmitter m consumes energy $E_m(k)$ from its battery to transmit data to the FC at time k . (For more information on the transmission model see the next subsection.) Note that $E_m(k)$ only describes the amount of energy required to transmit the current sensor measurement to the FC.

Each sensor is fitted with a unit to share energy with neighboring nodes, that is, to transmit energy to neighboring nodes and to receive energy from neighboring nodes. It is assumed that the wireless energy transfer is realized in a directed fashion. Possible technical realizations include energy transfer between

two resonant objects such as discussed in [13] and similar results in [14], the use of laser beams, or by the use of beam-forming radiowaves. Hence, the amount of energy transferred from one node to each neighboring node is assumed to be independent. The set of neighboring nodes from which sensor m can receive energy is denoted by $\mathcal{N}_{R,m}$ and the set of neighboring nodes to which sensor m can transmit energy is denoted by $\mathcal{N}_{T,m}$. Transferring energy is subject to losses. The efficiency of the energy transfer link from sensor m to sensor n is given by $\eta_{m,n} < 1$. Thus, out of the energy transferred from sensor m to sensor n at time slot k , denoted by $T_{m,n}(k)$, sensor n receives $\eta_{m,n}T_{m,n}(k)$, which is stored in sensor n 's battery and can be used for data transmission or energy sharing at time slot $k+1$. Note that in general, the efficiencies $\eta_{m,n}$ can be functions of time, i.e. $\eta_{m,n}(k)$. Unless explicitly mentioned we will assume time-invariant efficiencies in this paper. As discussed later, some of our results can be extended to the case of time-varying efficiencies.

Using the notation above, the dynamics of the battery level of sensor m at time $k+1$ is

$$B_m(k+1) = \min \left\{ B_m(k) + H_m(k) - E_m(k) - \sum_{n \in \mathcal{N}_{T,m}} T_{m,n}(k) + \sum_{n \in \mathcal{N}_{R,m}} \eta_{n,m} T_{n,m}(k); \hat{B}_m \right\} \quad (2)$$

where \hat{B}_m denotes the maximal battery capacity of sensor m .

C. Transmission Model

Each sensor has a transmitter and all transmitters adopt an analog amplify and forward uncoded strategy. This implies that at each time instant k , the transmitted signal from sensor m is the measurement $x_m(k)$ amplified by a factor of $\sqrt{\alpha_m(k)}$. Without loss of generality, we assume that each transmission slot is of duration unity. The energy necessary to transmit this signal is then given by

$$E_m(k) = \alpha_m(k) (\sigma_\theta^2 + \sigma_m^2). \quad (3)$$

The channel power gain of the m -th channel (between sensor m and the FC), $g_m(k)$, is assumed to follow an i.i.d. block fading process where within each block, the channel remains constant and changes independently from block to block. The duration of each fading block is assumed to be the same as the duration of each transmission slot. The received signal at the FC from sensor m at time k is thus given by $z_m(k) = \sqrt{\alpha_m(k)}g_m(k)x_m(k) + \zeta_m(k)$ where $\zeta_m(k)$ is assumed to be i.i.d. additive white Gaussian noise with variance ξ_m^2 . Note that here we assume an orthogonal multiple access scheme between the sensors and the FC which can be implemented via techniques such as orthogonal frequency division multiple access (OFDMA).

D. Information Patterns

In this paper, we will consider two different types of information pattern available for computing the optimal transmission energy and energy transfer policies. In the first instance

(Section III), we will assume a *non-causal* information pattern where the FC knows all sensors' channel gains and harvested energy levels (and hence battery levels) of all (including past, present and future) time slots. This information pattern is clearly impractical, but serves an important purpose of providing a benchmark of the optimal distortion performance attainable and can be used for comparing the performance of various other algorithms.

The second information pattern considered in this paper (Sections V and VI) is the *causal* information pattern where only information of current and past channel gains and harvested energies is assumed. Under this scenario, we consider two possible sub-cases: *centralized* and *decentralized*. In the *centralized* case, the FC has causal information of all the channel gains, and harvested energies (and hence battery levels) of all sensors. This can be achieved in practice by the FC transmitting periodic (at the beginning of each transmission slot) pilot signals to the sensors, from which the sensors estimate their channels and report back their channel gains and harvested energies (from the previous slot) to the FC via orthogonal control channels. In this case, the channels between the sensors and the FC are assumed to be reciprocal, such as in the time-division-duplex (TDD) framework. In both the non-causal case and the causal centralized case, the FC computes the optimal energy allocation policies and inform the sensors at each slot.

In the *decentralized* scenario, we assume that each sensor has causal information about its own instantaneous channel gains (using similar pilot transmissions from the FC and channel reciprocity) and harvested energies only. The sensors also report the channel gains to the FC so that the FC can compute the minimum mean square error (MMSE) estimate of the source (or the best-linear unbiased estimate (BLUE) if the Gaussianity assumptions are violated). In this case, the sensors only have statistical (distributional) information about the channel gains and harvested energy levels of the other sensors. For more details on this scenario, see Section VI.

It should be noted that the communication overhead between the sensors to the FC for reporting channel gains and battery levels also consumes energy at the sensors, which is not taken into account in this work. Note however, that if this energy consumption is constant for each transmission slot, then it can be easily taken into account by subtracting this energy from the maximum battery level and defining a modified maximum battery level for each sensor. Of course, it is assumed that the minimum battery level is large enough to support this communication overhead.

E. Distortion Measure at the Fusion Center

At the FC the best linear unbiased estimator, [29], provides the estimate $\hat{\theta}(k)$ given the vector of received signals $\mathbf{z}(k)$:

$$\hat{\theta}(k) = (\mathbf{h}^T(k)\mathbf{R}^{-1}(k)\mathbf{h}(k))^{-1} \mathbf{h}^T(k)\mathbf{R}^{-1}(k)\mathbf{z}(k) \quad (4)$$

where $\mathbf{h}(k) \in \mathbb{R}^{M \times 1}$ with entries $h_m(k) = \sqrt{\alpha_m(k)g_m(k)}$, $\mathbf{R}(k) \in \mathbb{R}^{M \times M}$ is a diagonal matrix where $R_{m,m}(k) = \sigma_m^2 \alpha_m(k)g_m(k) + \xi_m^2$ and $\mathbf{z}(k)$ is the vector of received

signals, i. e. $(z_1(k), z_2(k), \dots, z_M(k))^T$.¹ Then, the distortion measure at the FC is given by

$$\begin{aligned} \text{Var}(\hat{\theta}(k)) &= (\mathbf{h}^T(k)\mathbf{R}^{-1}(k)\mathbf{h}(k))^{-1} \\ &= \left(\sum_{m=1}^M \frac{\alpha_m(k)g_m(k)}{\sigma_m^2 \alpha_m(k)g_m(k) + \xi_m^2} \right)^{-1} \end{aligned} \quad (5)$$

Denoting $D(\mathbf{E}(k), \mathbf{s}(k)) := \text{Var}(\hat{\theta}(k))$, $s_m(k) := \frac{g_m(k)}{\xi_m^2(\sigma_\theta^2 + \sigma_m^2)}$ and $d_m(E_m(k), s_m(k)) := \frac{E_m(k)s_m(k)}{1 + \sigma_m^2 E_m(k)s_m(k)}$ with $E_m(k)$ in (3), the achieved distortion at the FC at time slot k is

$$\begin{aligned} D(\mathbf{E}(k), \mathbf{s}(k)) &= \begin{cases} \frac{1}{\sum_m d_m(E_m(k), s_m(k))} & \text{if } \sum_m E_m(k)g_m(k) > 0 \\ \sigma_\theta^2 & \text{if } \sum_m E_m(k)g_m(k) = 0 \end{cases} \end{aligned} \quad (6)$$

where $\mathbf{E}(k) = (E_1(k) \ E_2(k) \ \dots \ E_M(k))^T$ is the vector of transmission energies $E_m(k)$, and $\mathbf{s}(k) = (s_1(k) \ s_2(k) \ \dots \ s_M(k))^T$ is the channel to signal and noise ratio. In case no sensor is transmitting, the optimal estimate is simply $\hat{\theta}(k) = \mathbb{E}[\theta(k)] = 0$ with the distortion $D(\mathbf{0}, \mathbf{s}(k)) = \sigma_\theta^2$. It is well known that the distortion measure $D(\mathbf{E}(k), \mathbf{s}(k))$ is convex in $\mathbf{E}(k) > 0$ with a discontinuity at the boundary point $\mathbf{E}(k) = \mathbf{0}$.

III. FINITE-TIME HORIZON ENERGY ALLOCATION WITH NON-CAUSAL INFORMATION AND UNLIMITED BATTERY CAPACITY

In this section we derive the optimal energy allocation policy for minimizing the sum distortion over a finite horizon K and *a priori* knowledge of the channel gains and the harvested energies (and hence the battery levels) for $k = 1, \dots, K$ of all sensors, at the FC. It will also be assumed that each sensor has an unlimited battery, such that the battery equation of sensor m at time $k + 1$ can be written as (c.f. (2))

$$\begin{aligned} B_m(k+1) &= B_m(k) + H_m(k) - E_m(k) \\ &\quad - \sum_{n \in \mathcal{N}_{T,m}} T_{m,n}(k) + \sum_{n \in \mathcal{N}_{R,m}} \eta_{n,m} T_{n,m}(k). \end{aligned} \quad (7)$$

Define $\mathbf{T}(k)$ as the matrix with entries $(\mathbf{T}(k))_{m,n} = T_{m,n}(k)$ for $n \in \mathcal{N}_{T,m}$ and $(\mathbf{T}(k))_{m,n} = 0$ otherwise. Our aim is to find the optimal energy allocation $\{(\mathbf{E}(k), \mathbf{T}(k))\} : k = 1, \dots, K$ that solves the following problem:

$$\begin{aligned} \min_{\mathbf{E}(k), \mathbf{T}(k): 1 \leq k \leq K} & \sum_{k=1}^K D(\mathbf{E}(k), \mathbf{s}(k)) \\ \text{s.t. } & E_m(k), T_{m,n}(k) \geq 0 \text{ and } E_m(k) + \sum_{n \in \mathcal{N}_{T,m}} T_{m,n}(k) \leq B_m(k) \end{aligned} \quad (8)$$

a.s. for $1 \leq m, n \leq M$ and $1 \leq k \leq K$, and $B_m(k)$ satisfies (2). It is obvious that due to the convexity of the objective

¹It is assumed that the sensor noise parameters σ_m , and the channel noise variances ξ_m are known at the FC.

function and the linearity of the constraints, the optimization problem (8) is convex.

A. Lagrangian Formulation

The Lagrangian formulation for this problem, given the Lagrange multipliers $\lambda_{m,k} \geq 0$, $m = 1, 2, \dots, M$, $k = 1, 2, \dots, K$ is [34],

$$\begin{aligned} \mathcal{L}(\mathbf{E}, \mathbf{T}, \boldsymbol{\lambda}) &= \sum_{k=1}^K \left[D(\mathbf{E}(k), \mathbf{s}(k)) + \sum_{m=1}^M \lambda_{m,k} \left(\sum_{l=1}^k E_m(l) \right. \right. \\ &\quad \left. \left. - \sum_{l=1}^{k-1} H_m(l) - B_m(1) + \sum_{l=1}^k \sum_{n \in \mathcal{N}_{T,m}} T_{m,n}(l) \right. \right. \\ &\quad \left. \left. - \sum_{l=1}^{k-1} \sum_{n \in \mathcal{N}_{R,m}} \eta_{n,m} T_{n,m}(l) \right) \right]. \end{aligned} \quad (9)$$

E_m^o , $T_{m,n}^o$, and $\lambda_{m,k}^o$ are primal and dual optimal solutions to (9) if and only if they satisfy the Karush-Kuhn-Tucker (KKT) optimality conditions for all m and all k , i. e.,

$$E_m(k) \geq 0, \quad T_{m,n}(k) \geq 0, \quad \lambda_{m,k} \geq 0, \quad (10)$$

$$\begin{aligned} &\sum_{l=1}^k E_m(l) - \sum_{l=1}^{k-1} H_m(l) - B_m(1) \\ &+ \sum_{l=1}^k \sum_{n \in \mathcal{N}_{T,m}} T_{m,n}(l) - \sum_{l=1}^{k-1} \sum_{n \in \mathcal{N}_{R,m}} \eta_{n,m} T_{n,m}(l) \leq 0, \end{aligned} \quad (11)$$

$$\begin{aligned} &\lambda_{m,k} \left(\sum_{l=1}^k E_m(l) - \sum_{l=1}^{k-1} H_m(l) - B_m(1) \right. \\ &\left. + \sum_{l=1}^k \sum_{n \in \mathcal{N}_{T,m}} T_{m,n}(l) - \sum_{l=1}^{k-1} \sum_{n \in \mathcal{N}_{R,m}} \eta_{n,m} T_{n,m}(l) \right) = 0, \end{aligned} \quad (12)$$

$$\frac{\partial \mathcal{L}}{\partial E_m(k)} \Big|_{E_m^o(k)} \begin{cases} \geq 0 & \text{for } E_m^o(k) = 0 \\ = 0 & \text{for } E_m^o(k) > 0 \end{cases} \quad (13)$$

$$\frac{\partial \mathcal{L}}{\partial T_{m,n}(k)} \Big|_{T_{m,n}^o(k)} \begin{cases} \geq 0 & \text{for } T_{m,n}^o(k) = 0 \\ = 0 & \text{for } \sum_{n \in \mathcal{N}_{T,m}} T_{m,n}^o(k) > 0 \end{cases} \quad (14)$$

B. Necessary Conditions for Energy Transfer

In this subsection, necessary conditions for energy transfer between any two sensors will be derived. The conditions depend on the inverted sum of future Lagrangian multipliers:

$$\nu_{m,k} := \left(\sum_{l=k}^K \lambda_{m,l} \right)^{-1} \quad (15)$$

As due to the KKT conditions $\lambda_{m,k} \geq 0$ for all m and k , it follows that $\nu_{m,k} \leq \nu_{m,k+1}$ for all m and $k < K$.

Lemma 1: If it is optimal to transmit energy from sensor m to sensor n at time k , that is $T_{m,n}^o(k) > 0$, then $\nu_{n,k+1} = \eta_{n,m} \nu_{m,k}$.

Proof: According to the KKT condition (14) it must be true that $\frac{\partial \mathcal{L}}{\partial T_{m,n}(k)} \Big|_{T_{m,n}^o(k)} = 0$ for $T_{m,n}^o(k) > 0$. Thus, evaluating the derivative of the Lagrangian with respect to $T_{m,n}^o(k)$ yields

$$\frac{\partial \mathcal{L}}{\partial T_{m,n}(k)} \Big|_{T_{m,n}^o(k)} = \sum_{l=k}^K \lambda_{m,l} - \eta_{m,n} \sum_{l=k+1}^K \lambda_{n,l} = 0. \quad (16)$$

Then by using (15) we arrive at the necessary condition. \square

It can further be shown that transferring energy between two sensors in both directions at the same time is not optimal:

Corollary 1: It is not optimal to transmit energy between any pair of neighboring nodes in both directions in the same time step, that is one cannot have $T_{m,n}^o(k) > 0$ and $T_{n,m}^o(k) > 0$ for all m, n and k .

Proof: The proof follows similar steps as in the proof of Lemma 1. The necessary conditions for $T_{m,n}^o(k) > 0$ and $T_{n,m}^o(k) > 0$ are then combined to derive the result. \square

An alternative proof, which also holds for time-varying efficiencies $\eta_{m,n}(k)$, can be found below.

Proof: Assume there exists an optimal policy in which at some time step k energy is transferred between the two sensors “1” and “2” in both directions, that is $T_{1,2}^o(k) > 0 \geq T_{2,1}^o(k) > 0$. Assume that the policy is changed such that $T_{2,1}^*(k) = 0$ and $T_{1,2}^*(k)$ is reduced such that the overall energy received by sensor 2 is as before. Hence, the battery level of sensor 2 at the next time step is identical in both policies. However, the energy balance for the first sensor is better in the alternative policy. The saved energy when applying the second policy can then be used in the following time step to transmit data to the FC with higher energy leading to a smaller distortion. Thus, the original policy is outperformed by the second policy and hence cannot be optimal. \square

Remark 1: There exists, however, one very special instance in which any $T_{n,m}^o(k) \geq 0$ and $T_{m,n}^o(k) \geq 0$ is optimal. Consider the case where the total harvested energy in all sensors together with the sum of all initial battery levels is accumulated at one node with the highest channel gain. Assume that setting all energy transfer efficiencies to 1 the accumulated energy is denoted by E_{sum} . If the distortion achieved by using E_{sum} with the best channel gain of all sensors for all times is greater than σ_θ^2 , then it is optimal not to transmit any data at any time step. In this case, it does not matter what the available energy is used for, apart from data transfer. Thus, any possible choice of $T_{n,m}^o(k) \geq 0$ and $T_{m,n}^o(k) \geq 0$ does not change the best achievable distortion and is thereby optimal. Note that this is clearly an extreme and highly undesirable worst case scenario. It follows from the discontinuity of the distortion function at $\mathbf{E} = 0$.

C. Energy Transfer via Relay Node

Our preceding analysis allows one to study whether it is useful to use nodes for relaying energy.

Lemma 2: Consider a system with at least three nodes m , n and p and energy transfer efficiencies $\eta_{m,n}$, $\eta_{n,p}$ and $\eta_{m,p}$. Then, transferring energy from sensor m to n at time step k and from n to p at k or $k+1$ can only be optimal if $\eta_{m,p} \leq \eta_{m,n} \eta_{n,p}$.

Proof: The proof follows similar steps as in Lemma 1 and Corollary 1. The necessary conditions for energy transfers $T_{m,n}^o$, $T_{n,p}^o$ and $T_{m,p}^o$ are combined to yield to result.

Remark 2: Note that this conclusion holds true for all $T_{m,n}^o(k) > 0$ and $T_{n,p}^o(k) > 0$ or $T_{n,p}^o(k+1) > 0$, that is even if not all energy received at node n from m is transferred to p or more energy than was received is transferred to p . Note further that the condition only holds for the same time step or two directly adjacent time steps and not any arbitrary time slots. Thus, it might be optimal to transfer energy from m to n at k and from n to p at a time step other than k or $k+1$ even if $\eta_{m,p} \geq \eta_{m,n}\eta_{n,p}$.

Remark 3: Under some conditions this result can be extended to systems with time varying efficiencies $\eta_{m,n}(k)$. This depends on the range of the efficiencies. Assume there exists a known lower bound for the efficiency between nodes m and p such that $\eta_{m,p}(k), \eta_{m,p}(k+1) \geq \underline{\eta}_{m,p}$. Assume further that the upper bounds for the efficiencies between sensors m and n , and between n and p are given by $\eta_{m,n}(k), \eta_{m,n}(k+1) \leq \bar{\eta}_{m,n}$ and $\eta_{n,p}(k), \eta_{n,p}(k+1) \leq \bar{\eta}_{n,p}$. Then, a necessary condition for using node n as a relay node instead of transferring energy directly between sensors m and p can be found to be $\underline{\eta}_{m,p} \leq \bar{\eta}_{m,n}\bar{\eta}_{n,p}$.

D. Optimal Energy Allocation Policy

The optimal policy (computed at the FC) to determine how much energy the sensors should use to transmit their measurements to the FC at any time step is given by the following theorem.

Theorem 1: Suppose that the FC has an unlimited battery capacity and access to non-causal information on the harvested energies and channel gains for all time steps and all sensors. Then the optimal energy allocation at time k at sensor m is

$$E_m^o(k) = \begin{cases} 0 & \text{if } D(\Omega^o(k), \mathbf{s}(k)) \geq \sigma_\theta^2 \\ \Omega_m^o(k) & \text{if } D(\Omega^o(k), \mathbf{s}(k)) < \sigma_\theta^2 \end{cases} \quad (17)$$

where $\Omega^o(k)$ is the vector of $\Omega_m^o(k)$ for $m = 1, \dots, M$, given by

$$\Omega_m^o(k) = \begin{cases} 0 & \text{if } \Omega_m(k) \leq 0 \\ \Omega_m(k) & \text{if } 0 < \Omega_m(k) < B_m^*(k) \\ B_m^*(k) & \text{if } \Omega_m(k) \geq B_m^*(k). \end{cases} \quad (18)$$

In (18),

$$\Omega_m(k) = \frac{D_k \sqrt{\nu_{m,k}}}{\sigma_m^2 \sqrt{s_m(k)}} - \frac{1}{\sigma_m^2 s_m(k)} \quad (19)$$

with the overall achieved distortion at time k denoted by D_k and the largest possible energy for data transmission at sensor m at time k

$$B_m^*(k) = B_m(0) + \sum_{l=1}^{k-1} H_m(l) - \sum_{l=1}^{k-1} E_m(l) + \sum_{l=1}^{k-1} \sum_{n \in \mathcal{N}_{R,m}} \eta_{n,m} T_{n,m}(l) - \sum_{l=1}^{k-1} \sum_{n \in \mathcal{N}_{T,m}} T_{m,n}(l). \quad (20)$$

Proof: By using the continuous part of the distortion function D , that is focusing on $\mathbf{E}(k) > 0$, the KKT condition (13) for $E_m^o(k) > 0$ yields

$$\left. \frac{\partial \mathcal{L}}{\partial E_m(k)} \right|_{E_m^o(k)} = - \frac{D_k^2 s_m(k)}{(1 + \sigma_m^2 E_m^o(k) s_m(k))^2} + \sum_{l=k}^K \lambda_{m,l} = 0. \quad (21)$$

Setting $\nu_{m,k} = (\sum_{l=k}^K \lambda_{m,l})^{-1}$ leads to (19). Whenever $\Omega_m(k)$ is within the achievable boundaries of 0 and the battery level $B_m^*(k)$ we have $\Omega_m^o(k) = \Omega_m(k)$. Otherwise $\Omega_m(k)$ will be saturated below at 0 and above at $B_m^*(k)$ to ensure the KKT conditions are satisfied.

In case choosing the optimal energy allocation policy $\Omega_m^o(k)$ leads to an overall distortion that is greater or equal to σ_θ^2 , it is optimal not to transmit any data, that is to set $E_m^o(k) = 0$, and to save the available energy for a future time step. \square

Remark 4: Note that this optimal policy also holds for the general case with time-varying efficiencies. However, when allowing time-varying efficiencies, the overall dynamics can change. This leads for instance to changed KKT coefficients $\lambda_{m,k}$ (and hence different $\nu_{m,k}$), which results in different $E_m^o(k)$.

With suitably chosen pre-specified positive values of ϵ, δ the optimal power allocation policy can be calculated by the following algorithm:

Algorithm 1: Computing the optimal energy allocation policy (non-causal scenario with infinite battery capacity)

1: Initialize $\lambda_{m,l} = \lambda_{m,l}^0 \geq 0$ for all $m \in \{1, 2, \dots, M\}$ and $l \in \{1, 2, \dots, K\}$.

2: Initialize $T_{m,n}^{o,0}(k) = 0, \forall m, n \in \{1, 2, \dots, M\}$ (where $m \neq n$) and $k \in \{1, 2, \dots, K\}$.

3: **repeat**

4: For $i = 0, 1, \dots$ (note that i is the iteration number)

1) Employing $\lambda_{m,k}^i$, where $m \in \{1, 2, \dots, M\}$ and $k \in \{1, 2, \dots, K\}$, use a nonlinear solver to obtain $\Omega_m(k)$ in (19), yielding the values of $\Omega_m^o(k)$ in (18) and, hence, the values of $E_m^o(k)$ in (17). Denote these values by $E_m^{o,i}(k)$.

2) Compute $T_{m,n}^{o,i+1}(k), \lambda_{m,l}^{i+1}, \forall m, n, l, k$ (with $n \neq m$), according to the following primal dual sub-gradient method:

$$T_{m,n}^{o,i+1}(k) = \left[T_{m,n}^{o,i}(k) - \epsilon \left(\sum_{l=k}^K \lambda_{m,l}^i - \eta_{m,n} \sum_{l=k+1}^K \lambda_{n,l}^i \right) \right]^+ \quad (22)$$

$$\lambda_{m,l}^{i+1} = \left[\lambda_{m,l}^i + \epsilon \left(\sum_{j=1}^l E_m(j) - \sum_{j=1}^{l-1} H_m(j) - B_m(1) + \sum_{j=1}^l \sum_{n \in \mathcal{N}_{T,m}} T_{m,n}(j) - \sum_{j=1}^{l-1} \sum_{n \in \mathcal{N}_{R,m}} \eta_{n,m} T_{n,m}(j) \right) \right]^+ \quad (23)$$

5: **until** Convergence: $|\lambda_{m,l}^{i+1} - \lambda_{m,l}^i| \leq \delta, \forall m, l$.

Note that in the above algorithm, ϵ denotes the step size for the sub-gradient algorithm and should be chosen sufficiently small to guarantee convergence, and δ denotes the accuracy

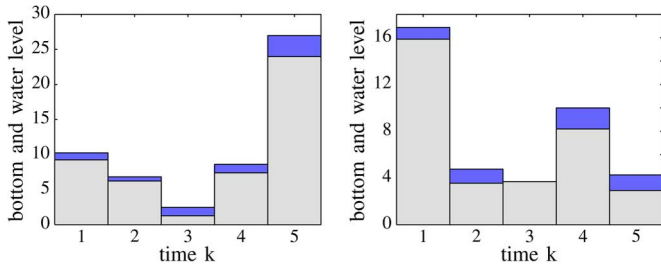

Fig. 2. Illustration of water filling algorithm: The grey shaded areas symbolize the tank bottoms and the blue shaded areas illustrate the amount of water in each tank for all time steps k for sensor 1 (left) and 2 (right).

threshold. Also, $[x]^+ = \max(x, 0)$. Note that one can use a time-varying decreasing threshold $\epsilon_i > 0$ satisfying $\sum_{i=1}^{\infty} \epsilon_i = \infty$, and $\sum_{i=1}^{\infty} \epsilon_i^2 < \infty$ for improved convergence. Finally, another alternative is to simply use a standard convex optimization software such as *CVX* that uses interior point methods.

E. Water Filling Algorithm Interpretation

The optimal energy allocation policy derived above can be interpreted as a two-dimensional water filling algorithm where water flows in one direction corresponding to the time from k to $k + 1$ and in the second dimension between sensors.

Consider the optimal energy allocation formula for $\Omega_m(k)$ in Theorem 1. The first right hand term in (19) can be interpreted as the water level for sensor m at time k . Note that the water level changes over time and differs between sensors. The height cannot be easily determined as it depends on the inverted sum of the Lagrangian multipliers, as well as the overall distortion.² The second right hand term in (19) can be interpreted as the height of the flat bottom of the water basin for sensor m at time k . The difference between the water level and the height of the bottom corresponds to the optimal energy used at sensor m at time k . This is illustrated in Fig. 2. The bottom areas drawn in grey illustrate the second right hand term of (19) while the blue shaded areas above illustrate the water in the tank, i.e. the optimal amount of energy used to transfer data to the FC.

Note, that energy causality has to be considered. Hence, only the energy stored in the battery can be used and energy harvested at time step k is only available for transmitting data at $k + 1$ or later. Thus, the water filling algorithm is directional, i.e. “water” can only flow from k to $k + 1$.

To understand the second dimension of the water filling algorithm describing the water or energy flow between the sensors, consider the optimal energy allocation for sensor n at time $k + 1$. Assume the overall distortion at the next time step is below σ_θ^2 and $E_n(k + 1)$ is between 0 and the battery level of sensor n at time $k + 1$. Assume further that it is optimal to transmit energy from sensor m to n at time k . Then, it must be true that $\eta_{m,n}\nu_{m,k} = \nu_{n,k+1}$. Substituting $\nu_{n,k+1}$ in $E_n(k + 1)$ leads to

²In case of constant channel gains, the algorithm is similar to the directional or staircase water filling algorithm shown to be optimal for wireless communications with energy harvesting constraints, full non-causal information and infinite battery capacity in [9], see also [35].

the following ratio between the water levels at sensor m at time k and sensor n at time $k + 1$

$$\begin{aligned} \frac{E_n(k + 1) + \frac{1}{\sigma_n^2 s_n(k+1)}}{E_m(k) + \frac{1}{\sigma_m^2 s_m(k)}} &= \sqrt{\eta_{m,n}} \frac{\frac{D_{k+1} \sqrt{\nu_{m,k}}}{\sigma_n^2 \sqrt{s_n(k+1)}}}{\frac{D_k \sqrt{\nu_{m,k}}}{\sigma_m^2 \sqrt{s_m(k)}}} \\ &= \sqrt{\eta_{m,n}} \frac{\frac{D_{k+1}}{\sigma_n^2 \sqrt{s_n(k+1)}}}{\frac{D_k}{\sigma_m^2 \sqrt{s_m(k)}}}. \end{aligned}$$

Thus, in case the necessary condition for $T_{m,n}^o(k) > 0$ is satisfied, energy is transmitted from sensor m to sensor n until the above equation is satisfied, or until the battery at sensor m is empty or the battery of n is full.

Remark 5: The above water filling algorithm is related to the two-dimensional directional water filling algorithm presented in [28]. However, in contrast to the algorithm in [28] the water levels of the algorithm presented here do not only depend on the inverted sum of Lagrangian multipliers, but also on the distortion and the time-varying channel gains (assumed to be fixed in [28]). Further, unlike our case, the heights of the water basin bottoms are constant over time in [28]. Another main difference lies in the fact that the two-dimensional directional water filling algorithm presented in [28] allows only to share energy in one direction, whereas the current setup allows for bi-directional energy transfer between neighboring sensors.

The two-dimensional water-filling algorithm presented here is a generalization of the directional algorithm presented in [28]. First, the approach considered here considers more than two sensors. Second, as energy can be transferred from sensor m to all sensors in $\mathcal{N}_{T,m}$ and received from all sensors in $\mathcal{N}_{R,m}$, it is not uni-directional in the second dimension, that is, between two sensors, as long as there exists a pair (m, n) such that $n \in \mathcal{N}_{T,m}$ and $n \in \mathcal{N}_{R,m}$.

IV. TWO SENSOR HORIZON 2 PROBLEM WITH NON-CAUSAL INFORMATION AND UNLIMITED BATTERY CAPACITY

In Section III, we showed that there is a closed form expression for the optimal energy allocation policy for the finite horizon case with non-causal information. However, it is difficult to fully understand the solution for any general K as the solution has to be obtained by iteratively solving a system of nonlinear equations. This section presents some structural properties of the optimal solution of the energy allocation problem of a simplified problem with two sensors, finite-time horizon $K = 2$, non-causal information and unlimited battery.

Assume that both sensors can harvest energy from their environment at time step $k = 1$, that is $H_1(1)$ and $H_2(1)$ and have the initial battery levels $B_1(1)$ and $B_2(1)$. Both sensors can use energy from their battery to transmit their measurements to the FC through a wireless fading channel with *a priori* known gains for sensor 1, that is $g_1(1)$ and $g_1(2)$, and for sensor 2, that is $g_2(1)$ and $g_2(2)$. Both sensors have a wireless energy transfer unit to transfer energy between each other. The energy transfer efficiencies are $\eta_{1,2}$ and $\eta_{2,1}$.

The aim is to find the energy allocation policy, that consists of the data transmission energies $E_1(1)$, $E_1(2)$, $E_2(1)$ and $E_2(2)$,

and the energy sharing quantities $T_{1,2}(1)$, $T_{1,2}(2)$, $T_{2,1}(1)$ and $T_{2,1}(2)$, to minimize

$$\begin{aligned} & \sum_{k=1}^2 D(\mathbf{E}(k), \mathbf{s}(k)) \\ &= \underbrace{\left(\frac{E_1(1)s_1(1)}{1 + \sigma_1 E_1(1)s_1(1)} + \frac{E_2(1)s_2(1)}{1 + \sigma_2 E_2(1)s_2(1)} \right)^{-1}}_{=:D_1} \\ &+ \underbrace{\left(\frac{E_1(2)s_1(2)}{1 + \sigma_1 E_1(2)s_1(2)} + \frac{E_2(2)s_2(2)}{1 + \sigma_2 E_2(2)s_2(2)} \right)^{-1}}_{=:D_2} \quad (24) \end{aligned}$$

subject to $E_m(k) \geq 0$, $T_{n,m}(k) \geq 0$, $E_m(k) + T_{m,n}(k) \leq B_m(k)$ and

$$B_m(2) = B_m(1) + H_m(1) - E_m(1) - T_{m,n}(1) + \eta_{n,m} T_{n,m}(1) \quad (25)$$

for $m, n \in \{1, 2\}$, $m \neq n$ and $k \in \{1, 2\}$.

It is optimal to use all remaining energy in the battery at the final time step $k = 2$ for data transmission to the FC. It is also optimal not to transfer any energy between the sensors at $k = 2$ as it could only be used in the third time slot. This yields the simplifications $T_{1,2}(2) = 0$ and $T_{2,1}(2) = 0$ and

$$E_1(2) = B_1(1) + H_1(1) - E_1(1) - T_{1,2}(1) + \eta_{2,1} T_{2,1}(1), \quad (26)$$

$$E_2(2) = B_2(1) + H_2(1) - E_2(1) - T_{2,1}(1) + \eta_{1,2} T_{1,2}(1). \quad (27)$$

Hence, the notation can be simplified by dropping the time index for the battery levels, $B_1(1) = B_1$ and $B_2(1) = B_2$, the harvested energies, $H_1(1) = H_1$ and $H_2(1) = H_2$, the energies used for data transfer, $E_1(1) = E_1$ and $E_2(1) = E_2$, and the amount of energy shared, $T_{1,2}(1) = T_{1,2}$ and $T_{2,1}(1) = T_{2,1}$.

A. Lagrangian Formulation

Using the simplified notation discussed above, the cost function in (24) and the energy constraints yield the associated Lagrangian

$$\begin{aligned} \mathcal{L}(E_1, E_2, T_{1,2}, T_{2,1}, \lambda_1, \lambda_2) &= D_1 + D_2 \\ &+ \lambda_1 (E_1 + T_{1,2} - B_1) + \lambda_2 (E_2 + T_{2,1} - B_2). \quad (28) \end{aligned}$$

In (28), $E_1^o, E_2^o, T_{1,2}^o, T_{2,1}^o$ and λ_1^o, λ_2^o are primal and dual optimal solutions if and only if they satisfy the KKT optimality conditions for $m, n \in \{1, 2\}$ and $m \neq n$

$$E_m \geq 0, \quad T_{m,n} \geq 0, \quad \lambda_m \geq 0, \quad (29)$$

$$E_m + T_{m,n} - B_m \leq 0, \quad \lambda_m (E_m + T_{m,n} - B_m) = 0, \quad (30)$$

$$\frac{\partial \mathcal{L}}{\partial E_m} \Big|_{E_m^o} \begin{cases} \geq 0 & \text{for } E_m^o = 0 \\ = 0 & \text{for } E_m^o > 0 \end{cases} \text{ and} \quad (31)$$

$$\frac{\partial \mathcal{L}}{\partial T_{m,n}} \Big|_{T_{m,n}^o} \begin{cases} \geq 0 & \text{for } T_{m,n}^o = 0 \\ = 0 & \text{for } T_{m,n}^o > 0 \end{cases}. \quad (32)$$

B. Necessary Conditions

For ease of exposition we will adopt the shorthand notation:

$$\begin{aligned} X_{1,1} &:= \frac{dD_1}{dE_1} = \frac{D_1^2 s_1(1)}{(1 + \sigma_1 E_1^o s_1(1))^2}, \\ X_{1,2} &:= \frac{dD_2}{dE_1} \\ &= \frac{D_2^2 s_1(2)}{(1 + \sigma_1 (B_1 + H_1 - E_1^o - T_{1,2}^o + \eta_{2,1} T_{2,1}^o) s_1(2))^2}, \\ X_{2,2} &:= \frac{dD_2}{dE_2} \\ &= \frac{D_2^2 s_2(2)}{(1 + \sigma_2 (B_2 + H_2 - E_2^o - T_{2,1}^o + \eta_{1,2} T_{1,2}^o) s_2(2))^2}. \end{aligned}$$

Lemma 3: If it is optimal to transmit energy from sensor 1 to 2 at time 1, that is $T_{1,2}^o > 0$, then $X_{1,2} \leq \eta_{1,2} X_{2,2}$. Similarly, if it is optimal to transfer energy from sensor 2 to sensor 1, then one must have $X_{2,2} \leq \eta_{2,1} X_{1,2}$.

Proof: Note that $\frac{\partial \mathcal{L}}{\partial T_{1,2}} \Big|_{T_{1,2}^o} = \lambda_1 + X_{1,2} - \eta_{1,2} X_{2,2}$ where $X_{m,k}$ can be seen as the weighted channel gain of sensor m at time step k . Together with condition (32) this yields the necessary condition for $T_{1,2}^o > 0$. The proof for energy transfer in the other directions follows similarly. \square

It also follows from the general M sensor case with non-causal information pattern that it is not optimal to transmit energy from sensor 1 to 2 and sensor 2 to 1 at the first time slot. A necessary optimality condition for data transmission to the FC can be obtained in a similar manner:

Lemma 4: If it is optimal to transfer data from sensor 1 to the FC at time 1, that is $E_1^o > 0$, then $X_{1,2} \leq X_{1,1}$.

Proof: The derivative $\frac{\partial \mathcal{L}}{\partial E_1} \Big|_{E_1^o}$ yields $\frac{\partial \mathcal{L}}{\partial E_1} \Big|_{E_1^o} = \lambda_1 - X_{1,1} + X_{1,2}$. Together with (31) this yields the necessary condition. \square

Finally, a necessary optimality condition for energy storing is simply $\lambda_1 = 0$.

C. Alternative Lagrangian Formulations

Given a positive battery level at the beginning of time slot 1 in the battery of sensor 1, that is $B_1 > 0$, there exist three possible ways of using the available energy:

- 1) using the energy for data transmission, that is $E_1 > 0$,
- 2) transferring energy to sensor 2, that is $T_{1,2} > 0$, and
- 3) storing energy for $k = 2$, that is $B_1 - E_1 - T_{1,2} > 0$.

If the quantities of two out of the three energy allocation possibilities are known, the third follows immediately. Thus, instead of minimizing the distortion by choosing the optimal quantities to be used to transfer data to the FC and transfer energy to sensor 2, minimizing the distortion by choosing the optimal quantities to store in the battery for the next time slot, that is

TABLE I
SUMMARY OF NECESSARY CONDITIONS

Condition for	From \mathcal{L}	From $\tilde{\mathcal{L}}$	From $\hat{\mathcal{L}}$
$E_1^o > 0$	$X_{1,2} \leq X_{1,1}$	$\tilde{\lambda}_1 = 0$	$\eta_{1,2}X_{2,2} \leq X_{1,1}$
$T_{1,2}^o > 0$	$X_{1,2} \leq \eta_{1,2}X_{2,2}$	$X_{1,1} \leq \eta_{1,2}X_{2,2}$	$\hat{\lambda}_1 = 0$
$F_1^o > 0$	$\lambda_1 = 0$	$X_{1,1} \leq X_{1,2}$	$\eta_{1,2}X_{2,2} \leq X_{1,2}$

$F_1 := B_1 - E_1 - T_{1,2}$, and to transfer energy to sensor 2 leads to the equivalent associated Lagrangian

$$\begin{aligned} & \tilde{\mathcal{L}}(F_1, F_2, T_{1,2}, T_{2,1}, \tilde{\lambda}_1, \tilde{\lambda}_2) \\ &= \frac{1}{\frac{(B_1 - F_1 - T_{1,2})s_1(1)}{1 + \sigma_1(B_1 - F_1 - T_{1,2})s_1(1)} + \frac{(B_2 - F_2 - T_{2,1})s_2(1)}{1 + \sigma_2(B_2 - F_2 - T_{2,1})s_2(1)}} \\ &+ \frac{1}{\frac{(F_1 + H_1 + \eta_{2,1}T_{2,1})s_1(2)}{1 + \sigma_1(F_1 + H_1 + \eta_{2,1}T_{2,1})s_1(2)} + \frac{(F_2 + H_2 + \eta_{1,2}T_{1,2})s_2(2)}{1 + \sigma_2(F_2 + H_2 + \eta_{1,2}T_{1,2})s_2(2)}} \\ &+ \tilde{\lambda}_1 (F_1 + T_{1,2} - B_1) + \tilde{\lambda}_2 (F_2 + T_{2,1} - B_2) \quad (33) \end{aligned}$$

with similar KKT conditions as discussed in Section IV-A.

A third possible model would be to use the energy that is used to transfer data to the FC and the energy which is stored in the batteries as variables (allowing to calculate the energy transferred between the sensors by $T_{1,2} = B_1 - E_1 - F_1$) leading to the equivalent Lagrangian formulation [see (34) at the bottom of the page] with again similar KKT conditions as in Section IV-A.

D. Necessary Conditions Derived From Alternative Lagrangian Formulations

Following similar steps as discussed in Sections IV-B it is possible to derive additional necessary conditions for $E_1^o > 0$, $T_{1,2}^o > 0$ and $F_1^o > 0$ from the two alternative Lagrangian formulations given in Section IV-C. An overview of all necessary conditions derived from the three Lagrangians is given in Table I.

As all three Lagrangians describe the same optimization problem, the result obtained from any of the three formulations must be the same. Thus, for instance for $E_1^o > 0$ all three necessary conditions must be satisfied, that is $X_{1,2} \leq X_{1,1}$, $\tilde{\lambda}_1 = 0$ and $\eta_{1,2}X_{2,2} \leq X_{1,1}$. In case it is optimal to use energy to transfer data to the FC from sensor 1 while at the same time transmitting energy to sensor 2, all corresponding necessary conditions must be satisfied. This can only be true if $X_{1,2} \leq X_{1,1} = \eta_{1,2}X_{2,2}$, $\tilde{\lambda}_1 = 0$ and $\hat{\lambda}_1 = 0$. Following the same reasoning, it can be shown that, in case it is optimal to simultaneously use energy to transfer data to the FC from

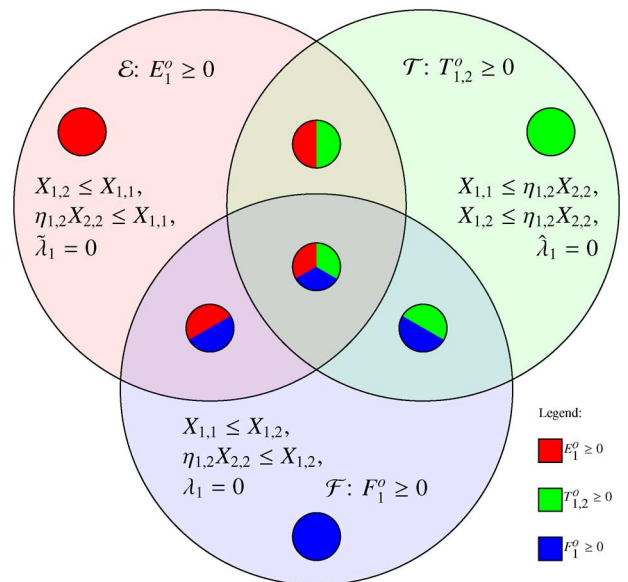

Fig. 3. Energy allocation sets.

sensor 1, transmit energy to sensor 2 and store energy, it must be true that $X_{1,1} = X_{1,2} = \eta_{1,2}X_{2,2}$, $\lambda_1 = 0$, $\tilde{\lambda}_1 = 0$ and $\hat{\lambda}_1 = 0$.

E. Graphical Interpretation of Necessary Conditions

Fig. 3 illustrates the interaction between the derived necessary conditions and the resulting energy usage regions. In this figure the set denoted \mathcal{E} (or \mathcal{T} or \mathcal{F}) includes all possible solutions where the necessary conditions for $E_1^o > 0$ (or $T_{1,2}^o > 0$ or $F_1^o > 0$, respectively) are satisfied. The set $\mathcal{E} \setminus (\mathcal{T} \cup \mathcal{F})$ includes all solutions for which the necessary conditions for $E_1^o > 0$ are satisfied, but the necessary conditions for $T_{1,2}^o > 0$ and $F_1^o > 0$ are not. Thus, it must hold that $E_1^o = B_1$ which is symbolized by a red pie chart; all available energy is used to transfer data to the FC in that case. The intersections of the different sets are marked by a mixture of the colors from the corresponding sets. In case the necessary conditions for $E_1^o > 0$ and for $T_{1,2}^o > 0$ are satisfied, but those for $F_1^o > 0$ are not, it must be true that $X_{1,2} \leq X_{1,1} = \eta_{1,2}X_{2,2}$, $\lambda_1 = 0$ and $\hat{\lambda}_1 = 0$. This corresponds to set $(\mathcal{E} \cap \mathcal{T}) \setminus \mathcal{F}$ illustrated by a pie chart with red and green. Here, all the available energy is used to transmit data to the FC and to transmit energy to the second sensor.

Unfortunately, it is not straightforward to determine the sizes of the different partitions of the sets and subsets shown in Fig. 3. The sizes shown in the figure are completely arbitrary and only to be interpreted as for illustration purposes. However, these necessary conditions lead to further insights of the underlying

$$\begin{aligned} & \hat{\mathcal{L}}(E_1, E_2, F_1, F_2, \hat{\lambda}_1, \hat{\lambda}_2) \\ &= \frac{1}{\frac{E_1 s_1(1)}{1 + \sigma_1 E_1 s_1(1)} + \frac{E_2 s_2(1)}{1 + \sigma_2 E_2 s_2(1)}} + \frac{1}{\frac{(F_1 + H_1 + \eta_{2,1}(B_2 - E_2 - F_2))s_1(2)}{1 + \sigma_1(F_1 + H_1 + \eta_{2,1}(B_2 - E_2 - F_2))s_1(2)} + \frac{(F_2 + H_2 + \eta_{1,2}(B_1 - E_1 - F_1))s_2(2)}{1 + \sigma_2(F_2 + H_2 + \eta_{1,2}(B_1 - E_1 - F_1))s_2(2)}} \\ &+ \hat{\lambda}_1 (E_1 + F_1 - B_1) + \hat{\lambda}_2 (E_2 + F_2 - B_2) \quad (34) \end{aligned}$$

problem of optimal energy allocation and will be used to develop a low-complexity heuristic energy allocation policy in Section VII.

V. FINITE-TIME HORIZON OPTIMAL TRANSMISSION ENERGY AND ENERGY SHARING WITH CAUSAL INFORMATION

In this section it will be discussed how to choose the optimal transmission energy for information transmission to the FC and the optimal energy for sharing between sensors to minimize the expected finite-time horizon sum distortion at the FC under the assumption that complete causal information is available at the FC. Under this information pattern, all sensors report their current battery levels and their estimated channel gains (achieved via pilot transmissions from the FC and channel reciprocity) to the FC via a control channel during the beginning of a transmission slot. Thus, the information available at the FC at k is $\mathcal{I}_k = \{\mathbf{g}(k), \mathbf{B}(k), \mathcal{I}_{k-1}\}$ where $\mathbf{g}(k) = (g_1(k), g_2(k), \dots, g_M(k))$ and $\mathbf{B}(k) = (B_1(k), B_2(k), \dots, B_M(k))$ are the complete vectors of all channel gains and battery levels at time k , and $\mathcal{I}_1 = \{\mathbf{g}(1), \mathbf{B}(1)\}$.

An energy allocation policy is a set of functions to determine $\{(E_m(k), \{T_{m,n}(k)\}) : m \in M, \text{ and } n \in \mathcal{N}_{T,m}\}$. It is feasible if the energy constraints $E_m(k) \geq 0$, $T_{m,n}(k) \geq 0$ and $E_m(k) + \sum_{n \in \mathcal{N}_{T,m}} T_{m,n}(k) \leq B_m(k)$ are almost surely (a.s.) satisfied for all $1 \leq m, n \leq M$ and $k \geq 1$. The admissible control set is then the set of all possible energy allocation policies which are based only on the causal information set \mathcal{I}_k and do not violate the energy constraints $E_m(k) \geq 0$, $T_{m,n}(k) \geq 0$ and $E_m(k) + \sum_{n \in \mathcal{N}_{T,m}} T_{m,n}(k) \leq B_m(k) \forall m$. Define $\mathbf{T}(k)$ as the matrix with entries $(\mathbf{T}(k))_{m,n} = T_{m,n}(k)$ for $n \in \mathcal{N}_{T,m}$ and $(\mathbf{T}(k))_{m,n} = 0$ otherwise. The finite-time horizon optimal transmission energy and energy sharing allocation problem which minimizes the expected sum distortion over a finite horizon subject to energy harvesting constraints is given by

$$\begin{aligned} \min_{\mathbf{E}(k), \mathbf{T}(k): 1 \leq k \leq K} \sum_{k=1}^K \mathbb{E} [D(\mathbf{E}(k), \mathbf{s}(k))] \\ \text{s.t. } E_m(k), T_{m,n}(k) \geq 0 \text{ and } E_m(k) + \sum_{n \in \mathcal{N}_{T,m}} T_{m,n}(k) \leq B_m(k) \end{aligned} \quad (35)$$

a.s. for $1 \leq m, n \leq M$ and $1 \leq k \leq K$, and $B_m(k)$ satisfies (2).

A. Finite-Time Horizon Optimal Energy Allocation Policy

For the causal information case where the future unpredictable wireless channel gains and energy harvesting information are not *a priori* known to the sensors, the solution to the stochastic control problem (35) is given by the following theorem:

Theorem 2: Let the initial condition be $\mathcal{I}_1 = \{\mathbf{g}(1), \mathbf{B}(1)\}$. Then the value of the finite-time horizon minimization problem (35) with causal information is given by $V_1(\mathbf{g}(1), \mathbf{B}(1))$, which can be computed recursively from the backward Bellman dynamic programming equation

$$\begin{aligned} V_k(\mathbf{g}, \mathbf{B}) = \min_{\mathbf{E}(k), \mathbf{T}(k)} \{D(\mathbf{E}(k), \mathbf{s}(k)) \\ + \mathbb{E}[V_{k+1}(\mathbf{g}(k+1), \mathbf{B}(k+1)) | \mathbf{E}(k), \mathbf{T}(k)]\} \end{aligned} \quad (36)$$

for $1 \leq k \leq K-1$ such that $E_m(k) \geq 0$, $T_{m,n}(k) \geq 0$ and $E_m(k) + \sum_{n \in \mathcal{N}_{T,m}} T_{m,n}(k) \leq B_m(k)$ with the battery dynamic equation (2) for all m . In (36), the expectation is computed over the random variables g and H , and the terminal condition is

$$V_K(\mathbf{g}, \mathbf{B}) = D(\mathbf{B}(K), \mathbf{s}(K)) \quad (37)$$

where all remaining energy is used up for transmission in the final time K .

Proof: The proof follows from the optimality equations for finite-time horizon stochastic control problems, [34]. \square

The solution to (35) is then given by

$$\begin{aligned} \{\mathbf{E}^o(k, \mathbf{g}, \mathbf{B}), \mathbf{T}^o(k, \mathbf{g}, \mathbf{B})\} = \arg \min_{\mathbf{E}(k), \mathbf{T}(k)} \{D(\mathbf{E}(k), \mathbf{s}(k)) \\ + \mathbb{E}[V_{k+1}(\mathbf{g}(k+1), \mathbf{B}(k+1)) | \mathbf{E}(k), \mathbf{T}(k)]\} \end{aligned} \quad (38)$$

for $1 \leq k \leq K-1$ such that $E_m(k) \geq 0$, $T_{m,n}(k) \geq 0$ and $E_m(k) + \sum_{n \in \mathcal{N}_{T,m}} T_{m,n}(k) \leq B_m(k)$ with battery dynamics (2) for all m and V_k is the solution to the Bellman equation (36).

In general the solution to the dynamic programming equation (38) can only be obtained numerically as there is no closed form solution. Since this numerical solution relies on computing the optimal policy for a large number of discretized channel gain and battery level values, we assume that this computation is done off-line at the FC (which has access to potentially unlimited energy and higher computational power) and stored in a look-up table. In real-time, as the FC receives the channel gains and battery level information of all sensors at the beginning of each transmission phase, the FC looks up the optimal energy allocation policies for the corresponding nearest discretized values of the channel gains and battery levels, and informs all the sensors via a feedback channel, which is assumed to be delay-free and error-free. The sensors subsequently use these optimal decisions for data transmission and energy sharing.

VI. DECENTRALIZED POLICIES

The case studied in Section V assumes the availability of causal centralized information, that is the current and past channel gains and battery levels of all sensors at the FC. However, it is desirable in practice to reduce the communication overhead required between each sensor and the FC. In this scenario, it is assumed that each sensor has causal information of its instantaneous harvested energies and channel gains (estimated via pilot signals transmitted from the FC) and only statistical (distributional) information of the remaining sensors' harvested energies and channel gains. For the generic sensor m , the distortion measure is then given by

$$\begin{aligned} \bar{D}_m(\mathbf{E}(k), g_m(k), \mathbb{P}(\mathbf{g}_{-m})) \\ = \int \left(\sum_{n=1}^M \frac{E_n(k) s_n(k)}{1 + \sigma_n^2 E_n(k) s_n(k)} \right)^{-1} \mathbb{P}(\mathbf{g}_{-m}) d\mathbf{g}_{-m} \end{aligned} \quad (39)$$

where $\mathbb{P}(\mathbf{g}_{-m})$ is the probability density function of the vector of channel gains excluding the channel gain of sensor m , that is, $\mathbf{g}_{-m} = (g_1 \ g_2 \ \dots \ g_{m-1} \ g_{m+1} \ \dots \ g_M)^T$, $s_n(k) = \frac{\bar{g}_n}{\xi_n^2(\sigma_n^2 + \sigma_n^2)}$ for $n \neq m$ with the mean channel gain $\bar{g}_n = \mathbb{E}\{g_n(k)\}$ and

$s_m(k) = \frac{g_m(k)}{\xi_n^2(\sigma_g^2 + \sigma_n^2)}$. Note that, as before, it is assumed that the channel gains are i.i.d. Thus, $\mathbf{P}(\mathbf{g}_{-m})$ and \bar{g}_n for $n \neq m$ are not functions of time.

Since sensor m has no access to the battery level information of the remaining sensors, it has to estimate the battery levels of the remaining sensors using the mean of the harvested energy at sensor n , $n \neq m$, i.e., $\bar{H}_n = \mathbb{E}(H_n(k))$.

The solution to the decentralized version of the stochastic control problem (35) is given in the following theorem.

Theorem 3: Given any sensor m and the initial condition $\mathcal{I}_{1,m} = \{g_m(1), \mathbf{B}(1)\}$ the value of the finite-time horizon minimization problem (35) with decentralized causal information is given by $V_{1,m}(g_m(1), \mathbf{B}(1))$, which can be computed recursively from the backward Bellman dynamic programming equation

$$V_{k,m}(g_m(k), \bar{\mathbf{B}}(k)) = \min_{\mathbf{E}(k), \mathbf{T}(k)} \left\{ \bar{D}_m(\mathbf{E}(k), g_m(k), \mathbf{P}(\mathbf{g}_{-m})) + \mathbb{E} [V_{k+1,m}(g_m(k+1), \bar{\mathbf{B}}(k+1)) | \mathbf{E}(k), \mathbf{T}(k)] \right\} \quad (40)$$

for $1 \leq k \leq K-1$ such that $E_m(k) \geq 0$, $T_{m,n}(k) \geq 0$ and $E_m(k) + \sum_{n \in \mathcal{N}_{T,m}} T_{m,n}(k) \leq \bar{B}_m(k)$ with

$$\bar{B}_n(k+1) = \min \left\{ \bar{B}_n(k) + \bar{H}_n - E_n(k) - \sum_{l \in \mathcal{N}_{T,n}} T_{n,l}(k) + \sum_{l \in \mathcal{N}_{R,n}} \eta_{l,n} T_{l,n}(k); \hat{B}_n \right\}. \quad (41)$$

for $n \neq m$ and $\bar{B}_m(k) = B_m(k)$ given by the battery dynamics equation (2). The expectation in (40) is computed over the random variables g and H . The terminal condition to the recursion (40) is

$$V_{K,m}(g_m(K), \bar{\mathbf{B}}(K)) = \bar{D}_m(\bar{\mathbf{B}}(K), g_m(K), \mathbf{P}(\mathbf{g}_{-m})) \quad (42)$$

where all available energy is used for transmission in the final time K .

Proof: The proof follows from the optimality equations for finite-time horizon stochastic control problems, [34]. \square

The solution to the decentralized stochastic control problem is then given by

$$\begin{aligned} & \{ \mathbf{E}^o(k, g_m(k), \bar{\mathbf{B}}(k)), \mathbf{T}^o(k, g_m(k), \bar{\mathbf{B}}(k)) \} \\ & = \arg \min_{\mathbf{E}(k), \mathbf{T}(k)} \left\{ \bar{D}_m(\mathbf{E}(k), g_m(k), \mathbf{P}(\mathbf{g}_{-m})) \right. \\ & \quad \left. + \mathbb{E} [V_{k+1,m}(g_m(k+1), \bar{\mathbf{B}}(k+1)) | \mathbf{E}(k), \mathbf{T}(k)] \right\} \end{aligned} \quad (43)$$

for $1 \leq k \leq K-1$ such that $E_n(k) \geq 0$, $T_{n,l}(k) \geq 0$ and $E_n(k) + \sum_{l \in \mathcal{N}_{T,n}} T_{n,l}(k) \leq \bar{B}_n(k)$ with (41) and V is the solution to the Bellman equation (40).

Note that, even though every sensor calculates the decentralized energy allocation policy for all sensors, it only applies its own policy. The remaining energy allocation policies for the other sensors are solely used to estimate the battery levels of the remaining sensor nodes using (41). Further note that the above decentralized energy allocation policy does not necessarily have

to be computed at the sensors if their computational resources are small. In fact, these policies can be calculated offline at the FC and stored in individual look-up tables for each sensor. These look-up tables then can be communicated to the sensors offline as well. In real time, each sensor can simply choose its energy allocation policy from this look-up table based on its own channel gain and battery level.

VII. HEURISTIC POLICIES

A. Moving Limited Time Horizon Policies

The optimal policies introduced above require a considerable computational effort to solve the backward Bellman dynamic programming equations (36), (40). Hence, simpler policies, which reduce the computational complexity and thus the time necessary to calculate the energy allocation policy are often desirable in practice. One way of reducing complexity is to reduce the finite time horizon and use a moving two step horizon. Such ideas can be used to reduce the computational complexity of both the policy requiring causal central information introduced in Section V as well as the policy relying only on causal local information discussed in Section VI.

B. Ad Hoc Policy

Another possibility is to use the known necessary optimality conditions to derive a suitable *ad hoc* policy. Assume a simple system with only two sensors where both agents can share energy between each other and have access to full causal information such as the maximal battery level, mean channel gains and harvested energies, energy transfer efficiencies as well as current channel gains and battery levels. Then, a simple *ad hoc* policy could be derived based on the necessary conditions derived in Section IV.

Since calculating the terms X_{11} , X_{12} and X_{22} requires non-causal information, the terms have to be greatly simplified. X_{11} is replaced by the corresponding actual channel gain of sensor 1. To simplify the calculations further and to ensure that only causal information is required, X_{12} and X_{22} are replaced by the mean channel gain of sensor 1 and 2. Hence, the necessary conditions for using energy for data transfer to the FC ($E_1(k) \geq 0$), for storing energy in the battery for future use ($F_1(k) \geq 0$) and for transferring energy to sensor 2 ($T_{1,2}(k) \geq 0$) are as follows:

$$E_1(k) \geq 0 \quad \text{if } g_1(k) \geq \bar{g}_1 \text{ and } g_1(k) \geq \eta_{1,2}\bar{g}_2 \quad (44)$$

$$F_1(k) \geq 0 \quad \text{if } \bar{g}_1 \geq g_1(k) \text{ and } \bar{g}_1 \geq \eta_{1,2}\bar{g}_2 \quad (45)$$

$$T_{1,2}(k) \geq 0 \quad \text{if } \eta_{1,2}\bar{g}_2 \geq g_1(k) \text{ and } \eta_{1,2}\bar{g}_2 \geq \bar{g}_1 \quad (46)$$

Hence, in case of unlimited battery capacity, these simple necessary conditions could be used to allocate the energy at time step k . However, since both batteries (at sensors 1 and 2) are limited, storing all energy at time k or transferring all energy from sensor 1 to sensor 2 at time k might be undesirable despite the necessary conditions (45) or (46) being satisfied. Storing all available energy in the battery or transferring all energy to sensor 2 could lead to preventable battery overflow. Thus, all three options (data transfer, storage, energy sharing) are prioritized in a certain order and energy is then allocated accordingly,

(based on the necessary conditions), with the aim of minimizing battery overflow and energy wastage.

This suggests the following basic rules:

- 1) Prioritise the three possible energy usage alternative, i.e. data transfer $E_1(k)$, storage $F_1(k)$ and energy sharing $T_{1,2}(k)$, by sorting $g_1(k)$, \bar{g}_1 and $\eta_{1,2}\bar{g}_2$ from highest to lowest.³ In case $g_1(k) = \bar{g}_1$ or $g_1(k) = \eta_{1,2}\bar{g}_2$, using energy for data transfer to the FC has the higher priority than storing energy or transferring it to sensor 2, respectively. In case $\bar{g}_1 = \eta_{1,2}\bar{g}_2$ storing energy has the higher priority than transferring it to sensor 2. Then allocate the available energy for data transfer, storing and energy transfer to sensor 2 according to their priorities.
- 2) If transferring data to the FC is the next highest priority, use all remaining energy to transfer data to the FC. (Hence, if data transfer has a higher priority than storage or energy transfer to sensor 2, no energy is allocated to storing or energy transfer to sensor 2, respectively.)
- 3) If storing energy has the next highest priority, all energy should be stored but never more than necessary to fill the battery to its maximal capacity minus twice the mean harvested energy. That is

$$F_1(k) = \min \left\{ \max \left\{ \hat{B}_1(k) - 2\bar{H}_1; 0 \right\}; B_1(k) \right\}.$$

In case there is more energy in the battery than should be stored, the remaining energy should be used according to the next following priority following the instructions in (2) or (4).

- 4) If transferring energy to sensor 2 has the next highest priority, transfer as much energy to sensor 2 to have its battery full for the next time step but not more than the battery capacity minus sensor twice its mean harvested energy. Therefore, $T_{1,2}(k)$ is given by

$$\min \left\{ \max \left\{ \left(\hat{B}_2 - B_2(k) + E_2(k) - 2\bar{H}_2 \right) / \eta_{1,2}; 0 \right\}; B_1(k) \right\}.$$

In case there is more energy in the battery than should be transferred, the remaining energy should be used according to the next following priority following the instructions in (2) or (3).

Remark 6: It should be noted that this heuristic policy favors transferring data to the FC if the current channel gain is higher than the mean. This policy works well for cases where the overall amount of energy available is low, i.e., due to low harvested energies or small battery capacity. If only little energy is available, it is beneficial to minimize the overall distortion by transmitting data whenever the channel gain is better than the mean. In contrast, if a lot of energy is already available due to higher mean harvested energy or higher battery capacity, increasing the energy for data transfer further in case of high channel gains leads to diminishing returns as far as distortion reduction is concerned. In these cases it would be better to use more energy to transfer data at time steps with less good channel gains. However, this simple policy cannot determine between these two fundamentally different scenarios. It is designed to

³For instance, if $\bar{g}_1 > g_1(k) > \eta_{1,2}\bar{g}_2$, storing energy has the highest priority followed by data transfer to the FC; and transferring energy to the second sensor has the lowest priority.

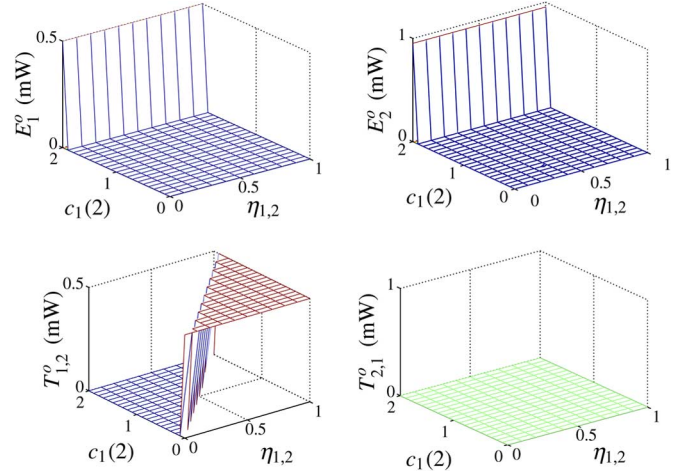

Fig. 4. Example 1, Scenario 1: $B_1 = 0.5$ mW.

work well for scenarios with overall little energy availability but its performance may not be as good when higher amounts of energy are available.

VIII. EXAMPLES AND NUMERICAL RESULTS

Example 1: We first consider the horizon 2 problem of a system with two sensors with unlimited battery capacity and non-causal information as discussed in Section IV. Let $\sigma_\theta^2 = 1$ mW, $\sigma_1^2 = 0.01$ mW and $\sigma_2^2 = 0.1$ mW. Assume that the first sensor harvests $H_1 = 1$ mW during the first time step, while the second sensor does not harvest energy. Consider that the following non-causal channel SNRs (in absolute scale) are known to both sensors: $c_1(1) = 1$, $c_2(1) = 1$, $c_2(2) = 2$ and $c_1(2)$ varies between 0 and 2, where $c_i(k) = \frac{g_i(k)}{\xi_i^2}$, $i = 1, 2$, $k = 1, 2$. Energy can be transferred between sensors and the efficiencies of the energy transfer links are $\eta_{2,1} = 0.5$ and $\eta_{1,2}$ varies between 0 and 1.

In the first scenario, assume that the initial battery levels of the two sensors are given by $B_1 = 0.5$ mW and $B_2 = 1$ mW. As shown in Fig. 4, E_1^o , E_2^o and $T_{2,1}^o$ are all zero for all $c_1(2)$ and $\eta_{1,2}$ in the given ranges. Hence, no energy is used to send any data to the FC at the first time step and no energy is transferred from sensor 2 to 1. It is optimal to send all available energy from sensor 1 to 2 or not to transfer any energy depending on the ratio of the energy efficiency $\eta_{1,2}$ and the channel SNR $c_1(2)$. Hence, it is not optimal to store or transfer only a portion of the available energy. This could be characterized by the “desperate scenario”: there is so little overall energy in the system that it is optimal to concentrate all available energy to send data to the FC at the second time step or even concentrate all energy to send data from the second sensor in case the channel gain of the first sensor is too poor and the energy transfer efficiency is sufficiently high.

In scenario 2, the initial battery level of sensor 1 is increased to $B_1 = 1.5$ mW. As illustrated in Fig. 5, it is not optimal to transfer any energy between the sensors (apart from the special case $\eta_{1,2} = 1$). Instead, all energy at the first sensor is used to send data to the FC. The energy used by sensor 2 to send data to the FC grows with the channel SNR $c_1(2)$. This could be characterized by the “greedy scenario”: The overall available energy in

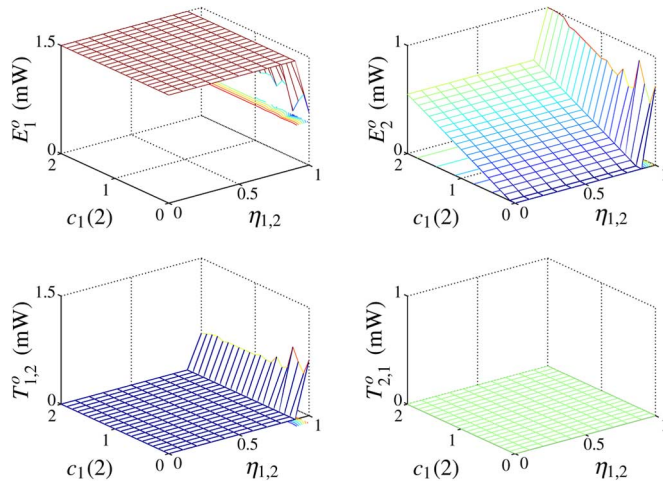
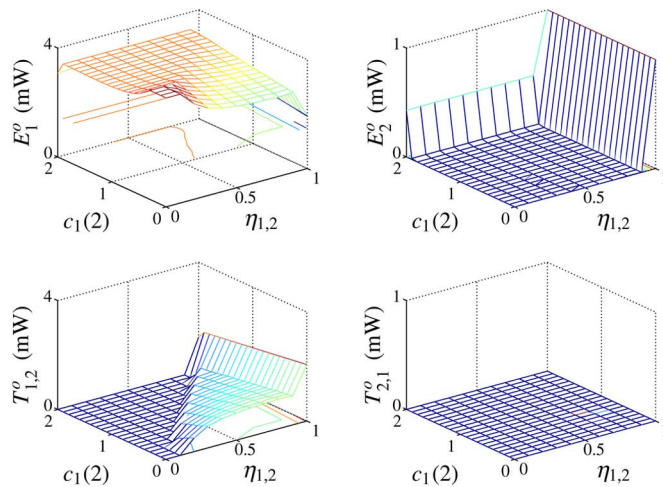
Fig. 5. Example 1, Scenario 2: $B_1 = 1.5$ mW.Fig. 6. Example 1, Scenario 3: $B_1 = 4$ mW.

the system is still low. Thus, each sensor accumulates its available energy in an optimal fashion locally but cannot afford to transfer any energy.

The initial battery level is further increased to $B_1 = 4$ mW in scenario 3. In contrast to the previous scenarios with less available energy in the system, both transferring energy from sensor 1 to 2 and sending data from sensor 1 to the FC is optimal for some values of $\eta_{1,2}$ and $c_1(2)$. In case no energy is transferred, sending data while also storing some energy in the battery for the next time step is optimal. See Fig. 6. This could be characterized by the “generous scenario”: The overall available energy is so high, that it is optimal to send data from sensor 1 to the FC at time step 1 while also being able to afford to share some of the energy or store it.

The example reveals that the optimal policies are far from trivial. Even for the most simple example with two sensors and two time steps the optimal policy cannot be easily deduced.

Example 2: (Double Sensor, Finite Horizon Problem with Varying Limited Battery Capacity). A system with two sensors and a finite horizon of $K = 5$ is simulated where $\eta_{1,2} = \eta_{2,1} = 0.8$, the channel SNRs c_1, c_2 , and the harvested energies H_1 and H_2 are chosen randomly using an exponential distribution

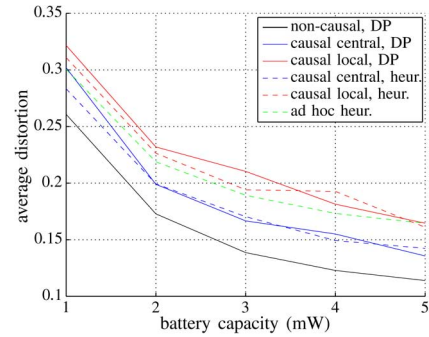
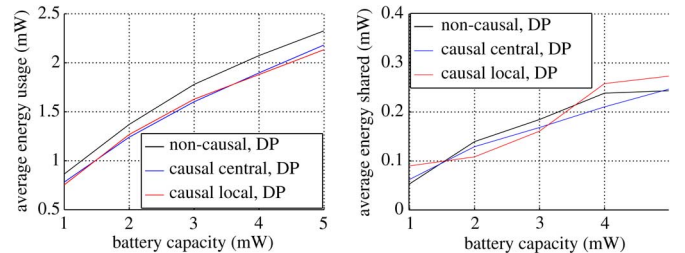

Fig. 7. Example 2: average distortion vs. battery capacity.

Fig. 8. Example 2: average energy usage for data transfer, i.e. $(E_1^o + E_2^o)/2$, (left), and average energy shared, i.e. $(T_{1,2}^o + T_{2,1}^o)/2$, (right); for the non-causal case (black), the causal, optimal case (blue) and the causal, decentralized case (red).

with $\mu_g = \mathbb{E}[c_i]/\xi_i^2 = 4$, $i = 1, 2$, and $\mu_H = 4$ mW each respectively.

To facilitate the implementation of the algorithms based on dynamic programming and causal information, the range of possible channel gains had to be divided into 10 discrete bins. Additionally the space for the battery levels and the space for energy allocation for data transfer or energy transfer to the neighboring sensor were discretized uniformly as multiples of 0.2 mW between 0 and \hat{B}_m , to facilitate the implementation of all three DP algorithms. Despite these discretizations, the dynamic programming based algorithms can be time-consuming for calculating the optimal energy allocation look-up tables, due to the well known *curse of dimensionality*. Unfortunately, the discretization of the channel gains and the decision variables leads to numerical inaccuracies which can be minimized by averaging over several simulations. This example was simulated twelve times using independent randomly generated numbers for the channel gains and harvested energies with the distributions described above. The average distortion and the average energy usages for these twelve simulations are illustrated in Fig. 7 and Fig. 8.

It is evident that increasing the battery capacities leads to an overall reduced distortion. As expected, the average distortion is the smallest for the algorithm using non-causal information (solid black line) while the optimal algorithm using centralized, causal information (solid blue line) performs almost as well as the algorithm with non-causal information. The algorithm using instantaneous local and statistical non-local information (red solid line) performs the worst of the three algorithms based on dynamic programming. The two heuristic algorithms using a moving two step time horizon (blue and red dashed lines) lead

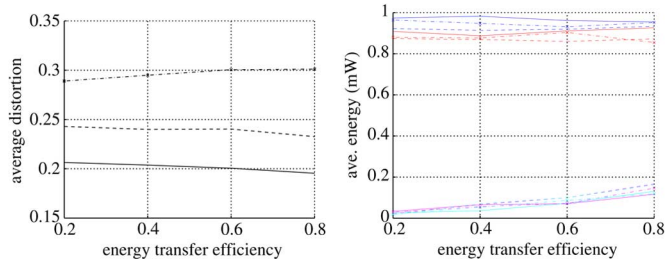

Fig. 9. Example 3: average distortion (black), E_1^o (red), E_2^o (blue), $T_{1,2}^o$ (magenta) and $T_{2,1}^o$ (light blue); for the non-causal case (straight lines), the causal, optimal case (dashed lines) and the causal, decentralized case (dash-dotted lines, 'x').

to a comparable performance as their full time horizon counterparts (blue and red solid lines). The heuristic *ad hoc* algorithm (green dashed line) performs better than the algorithms using local information for almost all battery capacity levels. Hence, it seems that given a low battery capacity, having access to centralized information (such as the battery levels of the neighboring nodes) is more effective in reducing the overall distortion than using dynamic programming to solve the backward Bellman equation. However, it can be expected that the performance of the *ad hoc* heuristic policy (green dashed line) worsens if the battery capacity is increased. (For details see Remark 6.)

It appears that, the large computational effort of using dynamic programming only gives a significant advantage if centralized information or a sufficiently large battery capacity are available. It should be noted that all, but the non-causal policy, depend on statistical information. Hence, the range of possible channel gains is divided into bins to numerically solve the dynamic programming equations. The simulation results thus can be affected by numerical inaccuracies, which perhaps explains why, in some cases, the policies using dynamic programming using a time horizon of $K = 5$ perform marginally worse than their heuristic counterparts.

Example 3: (Double Sensor, Finite Horizon Problem with Limited Battery Capacity and Varying Energy Transfer Efficiency). A similar system as in the previous example with a finite horizon of $K = 5$ is simulated. The channel SNRs and the harvested energy processes for the two sensors are chosen randomly using an exponential distribution with identical means $\mu_g = 4$ and $\mu_H = 1$ mW, respectively. The battery capacity is fixed at 3 mW, whereas the energy transfer efficiency varies between 0.2 and 0.8.

This example was simulated twelve times using independent randomly generated numbers for the channel gains and harvested energies. The average distortion and the average energy usages for these twelve simulations are illustrated in Fig. 9. The simulation results show that upon increasing the energy transfer efficiency, the average distortion decreases slightly in the non-causal and the causal, optimal (centralized) case (straight and dashed line respectively). However, in the causal, decentralized case, it seems increasing the efficiency does not have a favorable impact. The small increase observed in the average distortion in the decentralized case can be attributed to numerical effects of discretization of the battery levels and channel SNRs of the other agents while implementing the dynamic programming based solutions. We expect the average distortion

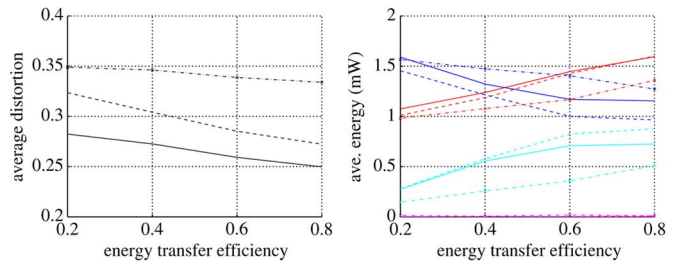

Fig. 10. Example 4: average distortion (black), E_1^o (red), E_2^o (blue), $T_{1,2}^o$ (magenta) and $T_{2,1}^o$ (light blue); for the non-causal case (straight lines), the causal, optimal case (dashed lines) and the causal, decentralized case (dash-dotted lines, 'x').

to decrease for higher transfer efficiencies even under the decentralized policy. However, this effect is marginal in the scenario where the two sensors have balanced energy harvesting and channel statistics. Keeping in mind that the number of discretization levels for the channel gains and battery levels play a key role in the reported distortion performance, it is likely that many more time-consuming simulations with increased number of discretization levels (due to the well known *curse of dimensionality in dynamic programming*) would be required to validate that. But given the insignificant positive effects even in the case of centralized or non-causal information, we draw the conclusion that increasing energy transfer efficiency has little influence on the distortion in a balanced scenario.

Example 4: (Double Sensor, Finite Horizon Problem with Limited Battery Capacity, Varying Energy Transfer Efficiency and Asymmetric Average Channel Gains and Harvested Energies). A similar system as in the previous example with a finite horizon of $K = 5$ is simulated. In contrast to Example 3 the channel SNRs and harvested energies at the two sensors have exponential distributions with different means. In particular, the mean values of c_1 and c_2 are $\mu_g^1 = 4$, and $\mu_g^2 = 1$ respectively, whereas H_1, H_2 have means and $\mu_H^1 = 1$ mW and $\mu_H^2 = 4$ mW, respectively. Hence, one agent harvests on average more energy but has on average a worse channel compared to the second sensor. The battery capacity is fixed at 3 mW and the energy transfer efficiency varies from 0.2 to 0.8.

This example was simulated twelve times using independent randomly generated numbers for the channel gains and harvested energies according to the distributions described above. The average distortion and the average energy usages for these twelve simulations are illustrated in Fig. 10. In contrast to the symmetric case in Example 3, the average distortion decreases in all three cases (non-causal (straight line), causal centralized (dashed line) and causal decentralized case (dash-dotted line)) when the efficiency increases. This indicates that an increased energy transfer efficiency leads to a more pronounced performance improvement in case of unbalanced scenarios where the average harvested energies and channel gains differ between the agents.

IX. CONCLUSIONS

In this paper, we studied the optimal energy allocation problem for minimizing a finite horizon sum distortion in a multiple sensor system where all sensors measure a random

process and send the measurements to the FC over fading channels using an analog amplify and forward uncoded strategy. The sensors have a limited battery capacity and can harvest energy from their environment to be used for data transmission or stored in the battery. The sensors can also receive energy from or transfer energy to neighboring sensors.

The optimal policy for transmission energy allocation and energy to be transferred between sensors with unlimited battery capacity and non-causal information was derived first. Additionally, some necessary optimality conditions for energy transfer between neighboring agents were given. The optimal energy allocation policy for the causal case is derived by solving a backward Bellman dynamic programming equation. Several necessary optimality conditions were also derived for the double sensor case with a finite-time horizon of 2 and unlimited battery capacities to gain more insight.

Several suboptimal policies were also derived. Some of these policies are decentralized in that they rely only on local information (and statistical information of neighboring nodes) to reduce the communication overhead of acquiring centralized information. Other suboptimal policies were proposed based on a moving 2-horizon reduced-complexity dynamic programming approach or heuristics based on insights obtained from the 2-sensor 2-horizon non-causal case.

Numerical simulations illustrate the technical results. It is shown that upon increasing the battery capacity the average distortion decreases in the non-causal and the causal case. When increasing the energy transfer efficiency, the average distortion also decreases. However, this effect is more pronounced in an unbalanced scenario, when one sensor on average harvests significantly more energy but has a significantly worse channel. Suboptimal policies can lead to good performance, depending on the system parameters.

Future extensions of this work will focus on long-term average distortion minimization over an infinite horizon with energy harvesting processes and fading channels that are temporally and spatially correlated, and also where the sensors measure a random field that is spatially correlated. Another interesting and challenging future direction is to develop algorithms that can be used in systems with time-varying infrastructure due to adding or removing sensors.

REFERENCES

- [1] I. Akyildiz, W. Su, Y. Sankarasubramaniam, and E. Cayirci, "A survey on sensor networks," *IEEE Commun. Mag.*, vol. 40, no. 8, pp. 102–114, Aug. 2002.
- [2] V. Gungor and G. Hancke, "Industrial wireless sensor networks: Challenges in design, principles and technical approaches," *IEEE Trans. Ind. Electron.*, vol. 56, no. 10, pp. 4258–4265, 2009.
- [3] C.-Y. Chong and S. Kumar, "Sensor networks: Evolution, opportunities and challenges," *Proc. IEEE*, vol. 91, no. 8, pp. 1247–1256, Apr. 2003.
- [4] V. Gungor, B. Lu, and G. Hancke, "Opportunities and challenges of wireless sensor networks in smart grid," *IEEE Trans. Ind. Electron.*, vol. 57, no. 10, pp. 3557–3564, Oct. 2010.
- [5] C. E. Jones, K. M. Sivalingam, P. Agrawal, and J. C. Chen, "A survey of energy efficient network protocols for wireless networks," *Wireless Netw.*, vol. 7, no. 4, pp. 343–358, 2001.
- [6] A. J. Goldsmith and S. B. Wicker, "Design challenges for energy-constrained *ad hoc* wireless networks," *IEEE Wireless Commun.*, vol. 9, no. 4, pp. 8–27, 2002.
- [7] D. E. Quevedo, A. Ahlén, and J. Østergaard, "Energy efficient state estimation with wireless sensors through the use of predictive power control and coding," *IEEE Trans. Signal Process.*, vol. 58, no. 9, pp. 4811–4823, Sep. 2010.
- [8] V. Sharma, U. Mukherji, V. Joseph, and S. Gupta, "Optimal energy management policies for energy harvesting sensor nodes," *IEEE Trans. Wireless Commun.*, vol. 9, no. 4, 2010.
- [9] C. K. Ho and R. Zhang, "Optimal energy allocation for wireless communications with energy harvesting constraints," *IEEE Trans. Signal Process.*, vol. 60, no. 9, pp. 4808–4818, Sep. 2012.
- [10] J. Yang, O. Ozel, and S. Ulukus, "Broadcasting with an energy harvesting rechargeable transmitter," *IEEE Trans. Wireless Commun.*, vol. 11, no. 2, pp. 571–583, Feb. 2012.
- [11] K. Tutuncuoglu and A. Yener, "Optimum transmission policies for battery limited energy harvesting nodes," *IEEE Trans. Wireless Commun.*, vol. 11, no. 3, pp. 1180–1189, Mar. 2012.
- [12] O. Ozel, K. Tutuncuoglu, J. Yang, S. Ulukus, and A. Yener, "Transmission with energy harvesting nodes in fading wireless channels: Optimal policies," *IEEE J. Sel. Areas Commun.*, vol. 29, no. 8, pp. 1732–1743, Sep. 2011.
- [13] A. Kurs, A. Karalis, R. Moffatt, J. D. Joannopoulos, P. Fisher, and M. Soljačić, "Wireless power transfer via strongly coupled magnetic resonances," *Science*, vol. 317, no. 83, pp. 83–86, Jul. 2007.
- [14] A. Karalis, J. D. Joannopoulos, and M. Soljačić, "Efficient wireless non-radiative mid-range energy transfer," *Ann. Phys.*, vol. 323, no. 1, pp. 34–48, Jan. 2008.
- [15] "The Wonders of Electricity," [Online]. Available: <http://news.softpedia.com/news/The-Wonders-of-Wireless-Electricity-475837.shtml>
- [16] "The Wireless Power Consortium," [Online]. Available: <http://www.wirelesspowerconsortium.com>
- [17] "Powercast," [Online]. Available: <http://www.powercastco.com>
- [18] "Starbucks to offer wireless recharging," [Online]. Available: <http://money.cnn.com/2014/06/12/technology/.../mobile/starbucks-recharging/>
- [19] "Plugless," [Online]. Available: <http://www.pluglesspower.com>
- [20] W. Lumpkins, "Nikola Tesla's dream realized: Wireless power energy harvesting," *IEEE Consum. Electron. Mag.*, vol. 3, no. 1, pp. 39–42, Jan. 2014.
- [21] A. M. Fouladgar and O. Simeone, "On the transfer of information and energy in multi-user systems," *IEEE Commun. Lett.*, vol. 16, no. 11, pp. 1733–1736, Nov. 2012.
- [22] R. Zhang and C. K. Ho, "MIMO broadcasting for simultaneous wireless information and power transfer," *IEEE Trans. Wireless Commun.*, vol. 12, no. 5, pp. 1989–2001, May 2013.
- [23] L. Liu, R. Zhang, and K.-C. Chua, "Wireless information and power transfer: A dynamic power splitting approach," *IEEE Trans. Commun.*, vol. 61, no. 9, pp. 3990–4001, Sep. 2013.
- [24] K. Huang and E. G. Larsson, "Simultaneous information and power transfer for broadband wireless systems," *IEEE Trans. Signal Process.*, vol. 61, no. 23, pp. 5972–5986, Dec. 2013.
- [25] K. Huang and V. K. N. Lau, "Enabling wireless power transfer in cellular networks: Architecture, modeling and deployment," *IEEE Trans. Wireless Commun.*, vol. 13, no. 2, pp. 902–912, 2014.
- [26] Y. Shi, L. Xie, Y. T. Hou, and H. D. Sherali, "On renewable sensor networks with wireless energy transfer," in *Proc. IEEE INFOCOM*, Apr. 2011, pp. 1350–1358.
- [27] L. Xie, Y. Shi, Y. T. Hou, W. Lou, H. D. Sherali, and S. F. Midkiff, "Renewable sensor networks with wireless energy transfer: The multi-node case," in *Proc. 9th Ann. IEEE Commun. Soc. Conf. Sens., Mesh Ad Hoc Commun. Netw.*, 2012, pp. 10–18.
- [28] B. Gurakan, O. Ozel, J. Yang, and S. Ulukus, "Energy cooperation in energy harvesting communications," *IEEE Trans. Commun.*, vol. 61, no. 12, pp. 4884–4898, Dec. 2013.
- [29] J. Mendel, *Lessons in Estimation Theory for Signal Processing*, ser. Communications and Control. Englewood Cliffs, NJ, USA: Prentice-Hall, 1995.
- [30] A. Limmanee, S. Dey, and A. Ahlén, "Distortion minimization via multiple sensors with energy harvesting," in *Proc. 14th IEEE SPAWC*, Jun. 2013, pp. 225–229.
- [31] M. Nourian, S. Dey, and A. Ahlén, "Distortion minimization in multi-sensor estimation with energy harvesting," *IEEE J. Sel. Areas Commun.*, 2015, accepted for publication.
- [32] C. Huang, Y. Zhou, T. Jiang, P. Zhang, and S. Cui, "Power allocation for joint estimation with energy harvesting constraints," in *Proc. IEEE ICASSP*, Vancouver, Canada, May 2013, pp. 4804–4808.

- [33] Y. Zhao, B. Chen, and R. Zhang, "Optimal power allocation for an energy harvesting estimation system," in *Proc. IEEE ICASSP*, Vancouver, Canada, May 2013, pp. 4549–4553.
- [34] D. P. Bertsekas, *Dynamic Programming and Optimal Control*, 3rd ed. New York, USA: Athena Scientific, 1995, vol. 1.
- [35] O. Ozel, J. Yang, and S. Ulukus, "Optimal transmission schemes for parallel and fading Gaussian broadcast channels with an energy harvesting rechargeable transmitter," *Comput. Commun.*, vol. 36, no. 12, pp. 1360–1372, 2013.



Steffi Knorn (M'13) received the Dipl.Ing. in 2008 from the University of Magdeburg, Germany, and the Ph.D. degree from the Hamilton Institute at the National University of Ireland Maynooth in 2013.

In 2013, she was a research academic at the University of Newcastle, Australia. Since 2014, she has been a Postdoctoral Researcher at Uppsala University, Uppsala, Sweden. Her research interests include multisensor estimation, energy harvesting, wireless energy transfer, two-dimensional systems, port-Hamiltonian systems, string stability, and

scalability of vehicle platoons and distributed control.



Subhrakanti Dey (M'96–SM'06) was born in India, in 1968. He received the B.Tech. and M.Tech. degrees from the Department of Electronics and Electrical Communication Engineering, Indian Institute of Technology, Kharagpur, in 1991 and 1993, respectively, and the Ph.D. degree from the Department of Systems Engineering, Research School of Information Sciences and Engineering, Australian National University, Canberra, in 1996.

He is currently a Professor with the Department of Engineering Sciences, Uppsala University, Sweden.

Prior to this, he was a Professor with the Department of Electrical and Electronic Engineering, University of Melbourne, Parkville, Australia, from 2000 until early 2013. From September 1995 to September 1997, and September 1998 to February 2000, he was a Postdoctoral Research Fellow with the Department of Systems Engineering, Australian National University. From September 1997 to September 1998, he was a Postdoctoral Research Associate with the Institute for Systems Research, University of Maryland, College Park, USA. His current research interests include networked control systems, wireless communications and networks, signal processing for sensor networks, and stochastic and adaptive estimation and control.

Professor Dey currently serves on the Editorial Board of IEEE TRANSACTIONS ON SIGNAL PROCESSING and Elsevier *Systems and Control Letters*. He was also an Associate Editor for the IEEE TRANSACTIONS ON SIGNAL PROCESSING during 2007–2010 and the IEEE TRANSACTIONS ON AUTOMATIC CONTROL during 2004–2007.



Anders Ahlén (S'80–M'84–SM'90) was born in Kalmar, Sweden, and received the Ph.D. degree in automatic control from Uppsala University, Sweden.

He is full professor and holds the Chair in Signal Processing at Uppsala University where he is also the Head of the Signals and Systems Division of The Department of Engineering Sciences. He was with the Systems and Control Group, Uppsala University, from 1984 to 1992 working as an Assistant and Associate Professor in Automatic Control. During 1991, he was a Visiting Researcher with the Department of Electrical and Computer Engineering, The University of Newcastle, Australia. He was a Visiting Professor at the same university in 2008. In 1992 he was appointed Associate Professor of Signal Processing at Uppsala University. During 2001–2004, he was the CEO of Dirac Research AB, a company offering state-of-the-art audio signal processing solutions, and is currently the Chairman of the Board. He was a member of the Center of Excellence in Wireless Sensor Networks, WISENET, from 2007 to 2013. His research interests, which include signal processing, communications and control, are currently focused on signal processing for wireless communications, wireless systems beyond 3G, wireless sensor networks, wireless control, and audio signal processing.

Dr. Ahlén was the Editor of Signal and Modulation Design for the IEEE TRANSACTIONS ON COMMUNICATIONS from 1998 to 2004.



Daniel E. Quevedo (S'97–M'05–SM'14) received the Ingeniero Civil Electrónico and M.Sc. degrees from the Universidad Técnica Federico Santa María, Chile, in 2000. In 2005, he received the Ph.D. degree from The University of Newcastle, Australia.

He subsequently held various research academic positions with The University of Newcastle, Australia. Currently, he holds the Chair in Automatic Control (Regelungs- und Automatisierungstechnik) at the University of Paderborn, Germany. He has been a visiting researcher at various institutions, including

Uppsala University, KTH Stockholm, Kyoto University, Karlsruher Institut für Technologie, University of Notre Dame, INRIA Grenoble, The Hong Kong University of Science and Technology, Aalborg University, and NTU Singapore. His research interests include several areas within automatic control, signal processing, and power electronics. He was supported by a full scholarship from the alumni association during his time at the Universidad Técnica Federico Santa María and received several university-wide prizes upon graduating.

Prof. Quevedo received the IEEE Conference on Decision and Control Best Student Paper Award in 2003 and was also a finalist in 2002. In 2009 he was awarded a five-year Research Fellowship from the Australian Research Council. He is Editor of the *International Journal of Robust and Nonlinear Control* and serves as Chair of the IEEE Control Systems Society Technical Committee on Networks and Communication Systems.